

Film-Tech

The information contained in this Adobe Acrobat pdf file is provided at your own risk and good judgment.

These manuals are designed to facilitate the exchange of information related to cinema projection and film handling, with no warranties nor obligations from the authors, for qualified field service engineers.

If you are not a qualified technician, please make no adjustments to anything you may read about in these Adobe manual downloads.

www.film-tech.com

Splicing for the Professional

INTRODUCTION

During the life of a 35 mm motion-picture release print, it is a rare exception if some splicing is not necessary. Each reel of a new print from a laboratory may contain at least one splice as the result of film stock conservation or normal printing techniques. Further initial splicing may be made in some areas by the distributor as directed by censor boards. The majority of splices in a print, however, are the direct result of theatrical use.

When a print arrives at a theater, it is a common practice to wind through the reels to check for damage, loose splices, and cleanliness. At that time, trailers and short subjects can be spliced on at the beginning or at the end of the appropriate reel. If local censor cuts have been directed, additional splicing is done where indicated. Theaters that employ automated projection systems require that the reels be spliced together for mounting onto one or two large reels or large horizontal platters. In both cases, the film leaders and trailers have to be cut from the appropriate reels and the print sections rejoined by splicing. At the end of the engagement, the print has to be disassembled and the film leaders and trailers respliced onto the correct reels. Upon return to the distributor or film exchange, if film inspection is warranted, more splicing may be necessary to repair the print and replace leaders and trailers. The history of an average release print,

therefore, illustrates the importance of proper splicing if an effective presentation is to be maintained.

TYPES OF SPLICES

Historically, the most commonly used splice in the industry has been the overlap cement type. As the description implies, the two ends of the film are joined by overlapping; then they are bonded by a suitable film cement. This oversimplification will be explained in detail later. The most common cement splice used in theaters and film exchanges is made on a bench-top splicer that includes a perforation in the overlap area. Some film exchanges employ an automatic splicer that places the overlap between perforations. Neither has an obvious advantage, but the wider overlap containing the perforation is considered somewhat more durable by many film technicians.

Over the past few years, the growing popularity of automated projection systems and, more recently, the limited availability of polyester base films, have influenced the emergence of the tape splice. This is a splice in which the film ends are securely fastened together by a very thin, perforated polyester tape with a pressure sensitive adhesive. Although commonly used for many years in the 8 mm and 16 mm field, the tape splice for 35 mm applications was not seriously considered before. The need for multiple splices and the loss of picture frames when making regular

overlap cement splices have motivated the popularity of tape splicing. During the assembly and disassembly of the large reels required in automated systems, conventional cement splices do in time account for the loss of significant picture information. On the other hand, tape splices can be disassembled without the loss of even one frame of film and then remade at the same location. Because of the relatively short time in which tape splices have become popular, there is not much definitive information or guidance currently available on the proper use of splicing tape in making splices. The Film Projection Practice Committee of the SMPTE has been investigating commonly used procedures with the intention of drafting suitable guidelines to promote standardization of tape splicing methods.

Tape splices can be made either with an overlap or with the two film ends butted together. There is an esthetic advantage to the butt-type splice on 35 mm prints, but the difficulty in making it properly with splicers now widely used in theaters and film exchanges suggests the overlap type as an alternative. Furthermore, the positioning pins on the bench-top splicers found in most theaters and exchanges are designed to correctly orient the film ends in the overlap position. The width of the overlap with tape splicing is not as important as it is in cement splicing, but should be sufficient to prevent hinging (or collapse) when the splice is flexed.

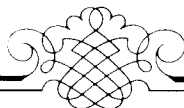

Academy Award for Best Picture

1975 *One Flew Over the Cuckoo's Nest*
1976 *Rocky*
1977 *Annie Hall*
1978 *The Deer Hunter*
1979 *Kramer vs. Kramer*
1980 *Ordinary People*
1981 *Chariots of Fire*
1982 *Gandhi*
1983 *Terms of Endearment*

MAKING CEMENT SPLICES

Splicing, whether done in film labs, film exchanges, or theaters, has such a direct bearing on the life of the film that it requires strict adherence to acknowledged appropriate splicing

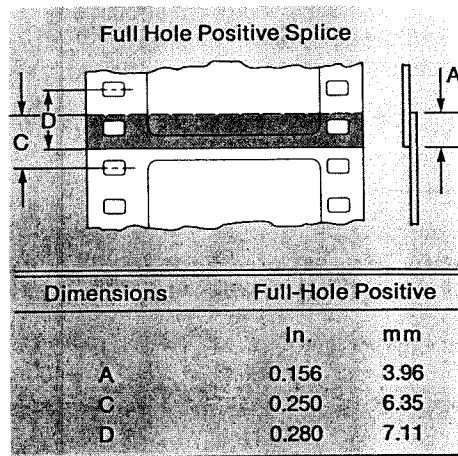
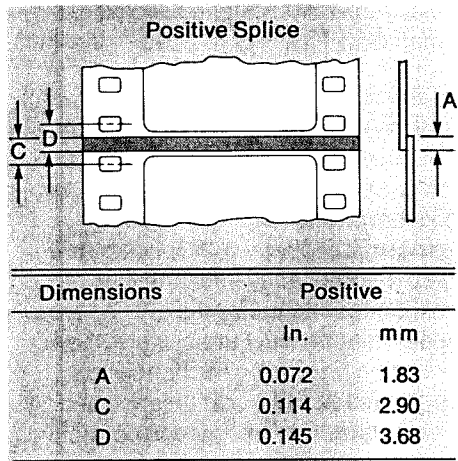
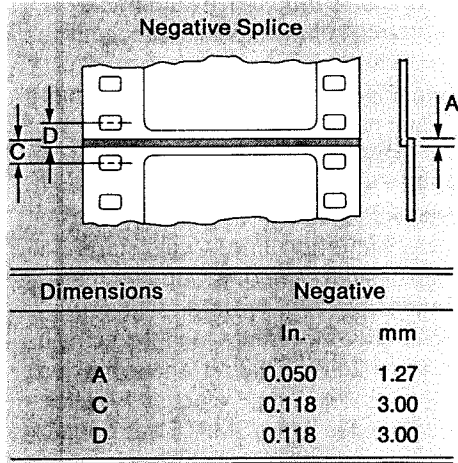

procedures. To make a proper splice, it is essential that the mechanics of a film splice become familiar. An overlap cement splice depends on the solvent action of a suitable cement which essentially welds the two prepared film surfaces as one.

American National Standard PH22.178-1971 specifies the dimensions and location of cemented transverse splices in 35 mm film. When using the most common bench-top splicer, the width of the overlap area will be 0.156 inch (3.96 mm) providing a full-hole positive splice. Other types of tabletop or portable splicers may produce a positive splice with an overlap width of 0.072 inch (1.83 mm) between perforations or a negative splice where the overlap measures 0.050 inch (1.27 mm), also between perforations (Figure 1). Similar standards (PH22.24-1965) are available for 16 mm cement splices (Figure 2). Standards for splicing 70 mm are not as clearly established. There is, however, an SMPTE Recommended

Practice (RP-23) which describes the reinforcement of 70 mm overlap cement splices with tape.

Motion picture film is constructed basically of three layers: an emulsion coating that consists chiefly of gelatin in which silver or dye forming the image is suspended; the binder, a microscopically thin layer between the emulsion coating and the base; and the base (or support), a flexible plastic material. In addition, some films have an antistatic or antihalation base coat or gelatin coat for added protection. Still others have a lubricant added on the base, edges, or emulsion side. Any foreign substance or emulsion and binder still present on the film surfaces will prevent the cement from providing the proper solvent action to make the splice.

Satisfactory splices demand careful scraping to make sure all the emulsion, binder, and any foreign substances are completely removed. Care must also be exercised in cutting the film sections so that they will be joined in frame.

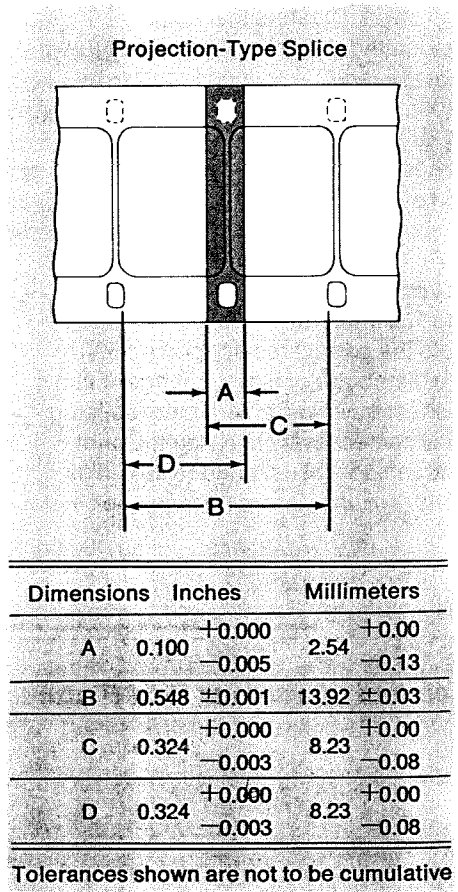
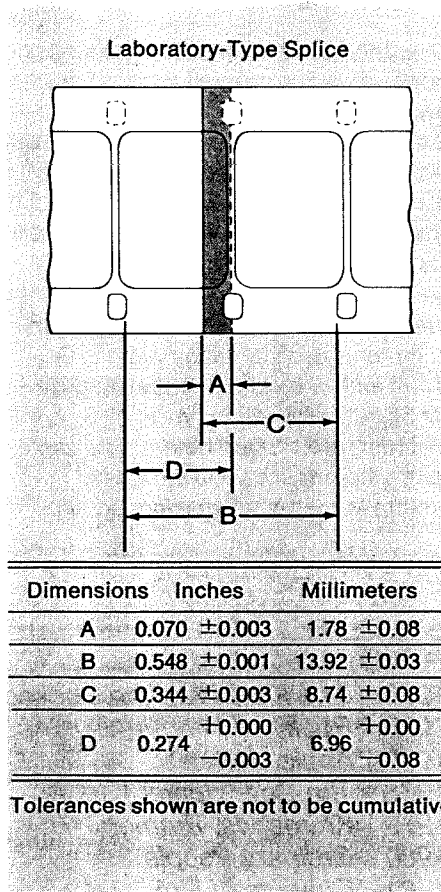

Figure 1
Dimensions and location of transverse cemented splices in 35 mm film.

Figure 2
Dimensions and location of transverse cemented splices in 16 mm film.



Figure 3

Griswold Film Splicer.

Courtesy Neumade Products Corporation, Scarsdale, New York.

This is not a problem with 8 mm and 16 mm film. Complete removal of the emulsion and binder layers from the splice area can be accomplished in several ways. With the most widely used bench-top splicer (Figure 3), a combination scraper and fine-wire brush works the best. While a razor blade or fine sandpaper can also be used, there is always the chance of scoring the scraped area or producing excessive dirt which can be carried into the roll. Another type of bench splicer (Figure 4) provides a rigid scraper blade that is drawn back and forth over the splice area to remove the emulsion and binder. This device makes excellent splices providing the scraper is kept sharp and correctly aligned. In any case, when the emulsion and binder have been completely removed, an evenly frosted scraped area will be seen (Figure 5).

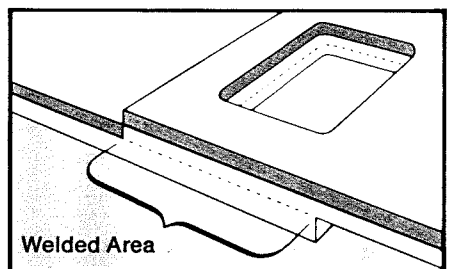
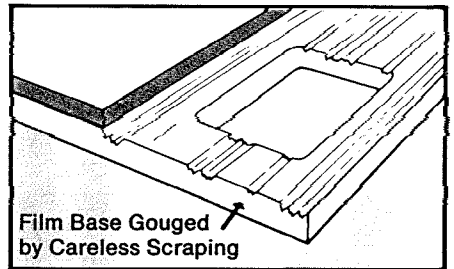
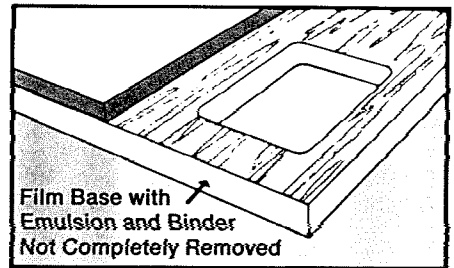
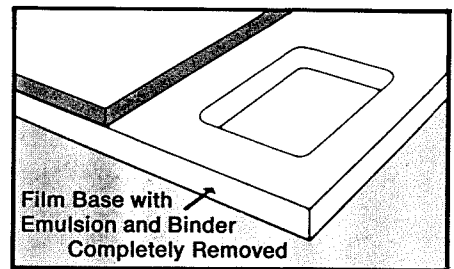

Figure 5

Some hints for preparing the splice area.

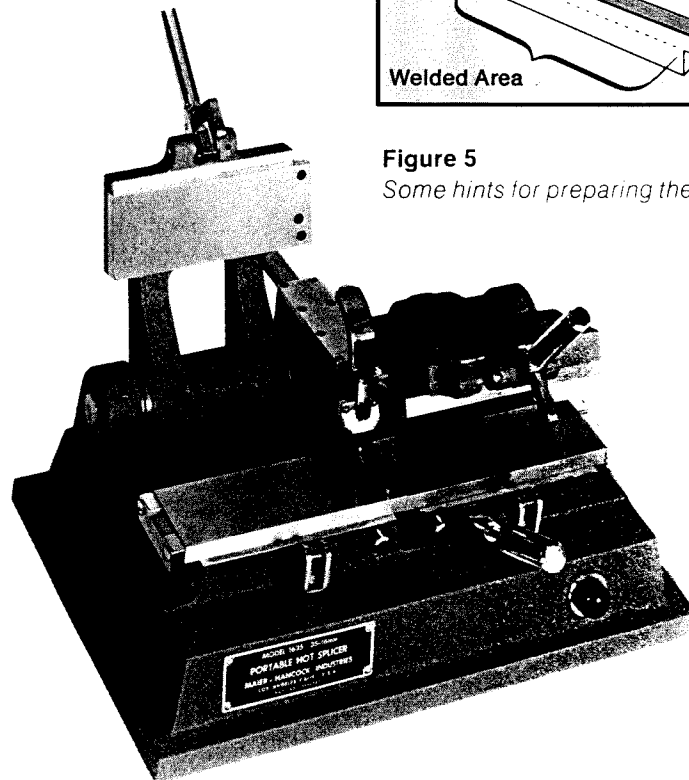

Figure 4

Maier-Hancock Portable Hot Splicer, Model 1635.

Courtesy Maier-Hancock Industries, North Hollywood, California.

Figure 6

To test the splice, gently flex the film in this way.

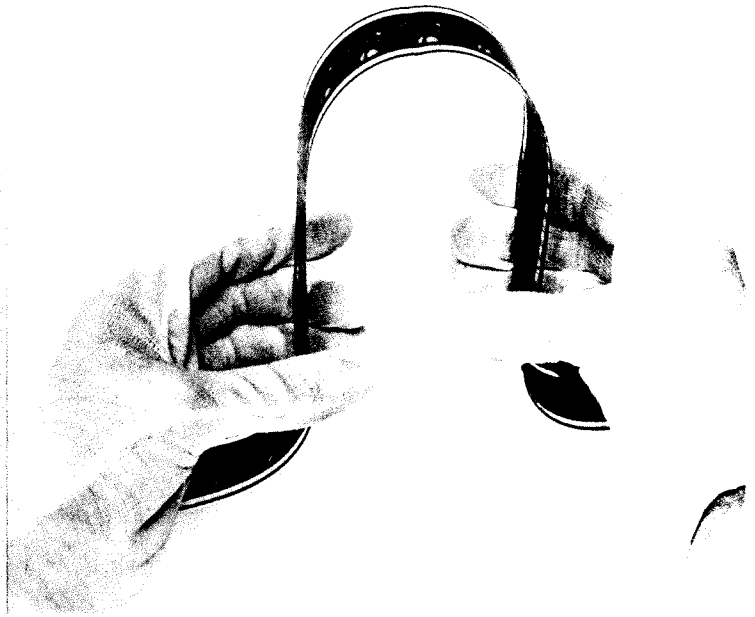

The surface on the base side of the film to be joined must also be thoroughly cleaned. Careful scraping is needed when magnetic sound tracks are present (do not use film cement to remove the magnetic track in the splice area because too much of the track may be removed). If the base surface contains even a slight film of oil, some difficulty may be encountered in obtaining successful splices. Very often this factor is overlooked and poor splices are falsely attributed to the particular cement used, to the splicing equipment, or to the film base itself. Sometimes it may be helpful to roughen the base surface slightly when certain films resist satisfactory splicing. An easier and more effective technique (if no magnetic track is present) is to apply a very small amount of cement to the base side splice area surface; then wipe it off immediately. This acts as a primer coating preliminary to the actual splicing operation, and it aids in obtaining thorough adhesion of the two surfaces to be joined.

When the emulsion and binder have been satisfactorily removed, the cement should be applied to the splice area. Enough cement should be used to wet the scraped area, but not so much that it will run outside the splice when the two sections of film are pressed together. It is important to allow sufficient holding time under pressure in the splicer. Mechanical adjustment of the splicer should

provide uniform pressure across the width of the film. For current safety film, about 10 to 15 seconds is recommended, although some splicers have heated platens to reduce splice drying time. At the end of the bonding time, the pressure may be released and the finished splice rubbed carefully with a soft cloth held over the finger to help seal the cut ends.

As was mentioned previously, a good splice is actually a weld whereby one section of the film is partly dissolved into the other. It should be emphasized that it is important to bring the two surfaces under pressure as quickly as possible after application of the cement. It is unnecessary, however, to slam the pressure clamp into position since this results in splashing of the cement. If the left clamp of the bench-top splicer is raised slightly when the cement is applied, the cement will be less apt to flow under the film and a cleaner back surface will be obtained. This will greatly reduce the possibility of distortion in the spliced area when the cement has dried. After a sufficient holding time, the splice may be tested by gently flexing the film as shown in Figure 6. Because a cement splice does not usually attain full strength for several hours, some care should be exercised when handling the film if immediate use is contemplated. A well made splice should not contain any bubbles or hazy areas that indicate an imperfect weld.

Some of the more common causes of unsatisfactory cement splices are:

1. Old film cement from which the essential solvents have evaporated. The practice of checking a film cement by its smell or viscosity is virtually useless. For everyday use, film cement should be stored in small bottles that will provide the least possible air space so as to retard evaporation.
2. Insufficient drying time.
3. Emulsion or binder not completely removed from the scraped area, causing an incomplete or faulty weld.
4. Excessive scraping, scratching, or gouging of the film base, weakening the base and causing the film to collapse or break at the splice.
5. Too much delay in bringing the film ends into contact after cement has been applied.
6. Applying too much cement. Excess solvent action will cause the splice to buckle. During projection, the splice may cause difficulty in the film gate or at a sprocket pad roller.
7. Applying too little cement, resulting in an incomplete weld. Such splices should be remade or they may come apart during projection.
8. Poor mechanical alignment of the splicer. This can cause a misaligned splice which could catch in the projector film path and tear apart.

The following are some hints on the use of film cement:

1. Keep the splice clamped at least 10 seconds (longer if practical) after the film ends have come into contact. Insufficient holding time is a prime cause of early splice failure.
2. Never add fresh cement to old in a work bottle. Start with new cement every day. Clean the bottle with a little fresh cement before refilling.
3. Keep the work bottle of cement tightly covered. The solvent in film cement evaporates rapidly.
4. Check the base side of the film for oil, dirt, or other deposits. Remove any base coating . . . preferably by applying and then wiping off the film cement in the splice area. Using film cement to remove 35 mm and 70 mm magnetic sound stripes is not recommended because too much stripe may be affected. Carefully scrape the base side to remove magnetic coatings.
5. Keep the splicer scrupulously clean and in correct alignment. Use film cement to remove cement buildup and scraps of film shavings. The cutting bar and all surfaces bearing on the film should also be kept clean and sharp.

MAKING TAPE SPLICES

A properly made tape splice may be considered quite permanent but it can be disassembled at any time, if necessary, and usually without damage to the film. Tape splices are becoming increasingly popular among the theaters that use large reel projection or automated projection systems. For those who wish to use films with polyester base (such as Kodak Estar base), tape splices are essential because polyester base films cannot be spliced with ordinary solvent-fusion methods. Some laboratories and other special applications use sophisticated thermal weld splicers for polyester base films, but most theaters and film exchanges have only bench-top splicers available. Furthermore, these

special devices cannot readily splice dissimilar materials, such as acetate to polyester or vice versa. Definitive guidelines or standards for tape splices have not been readily available, but the following procedures and recommendations are based on considerable experience and study.

An overlap tape splice made on a bench-top splicer can be compared to a similar cement splice with one exception. Instead of cement to bond the two film ends at the overlap, a piece of 35 mm perforated polyester tape is placed over the overlap on both sides of the film. With special splicers, unperforated tape is used and perforated during the splicing operation. There is no need to remove the emulsion and binder from the film, although it may be desirable if the splice is to be less noticeable on the screen.

At the present time, splicing tape is available in 35 mm perforated rolls

(such as Permacel 96 Kleer-Splice), 35 mm unperforated rolls, and 35 mm tape tabs (such as "Quick-Splice" T35-DP, by Hudson Photographic Industries, Inc.). There are advantages and disadvantages with each type of tape, but all types will make satisfactory splices. The main advantage of the perforated rolls is the ability to cut tapes of any length for film repair as well as short pieces for splicing. Another advantage is the lower cost per splice. The only disadvantage is a possible time loss because the thin tape is difficult to handle with unprotected adhesive. Very thin polyester splicing tape tends to move unpredictably due to static attraction, and efforts to place it over the splice in register with the film perforations and splicer pins can prove very frustrating at times. The unperforated 35 mm tape can be used only with special splicers, such as the one shown in Figure 7, that are designed to punch out the perforations in the tape area.

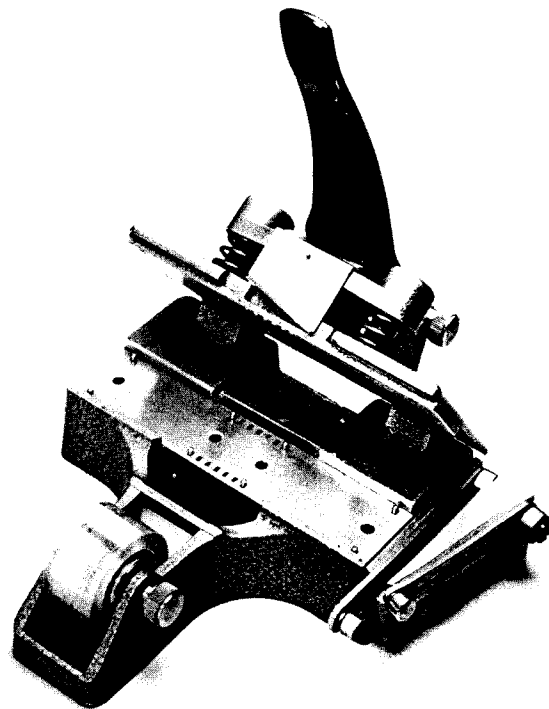

Figure 7 Guillotine Tape Splicer, Model FGU-013.
Courtesy S.O.S. Photo-Cine-Optics, Inc., New York, New York.

Perforated tape tabs, on the other hand, are simple to use but tend to be somewhat more expensive. Those currently available are only four perforations (one frame, Figure 8) in length. When making a proper splice, the picture area in the adjacent frames, divided by the splice will each contain two tape (Figure 9) ends that can be distracting on the screen.

For esthetic reasons, and for added strength, it is desirable to make an overlap tape splice with tape sections two frames long (Figure 10, eight perforations). This procedure places the tape ends at a frame line (Figure 11) for invisibility and provides for a greater adhesive area.

When making tape splices with a bench-top or block-type splicer, the following directions are important:

1. Cut the two ends of the film to be spliced in the normal manner as you would do when making a regular cement splice.
2. It is not necessary to scrape the left-hand section unless esthetic considerations are requested. Simply bring down the right-hand section so that the two film ends are in contact on the splicing block.
3. If you are using perforated tape on a roll, it is advisable to have a few two-frame (eight perforations) sections precut and placed on a nearby surface which will allow for easy grasp and release.
4. Lift both sections of the splicer and hold the film in position if it tends to pop up. Using your free hand, pick up a precut tape section and carefully place it over the splice, aligning it with the splicer pins and centering it so that either tape end falls on a frame line. Press the tape down casually to hold the two film sections together. Remove the film from the splicer and thoroughly rub the tape section with a soft, lint-free cloth to eliminate bubbles and wrinkles.
5. Turn the film over and replace it in the splicer. Place a second tape section on the splice corresponding to the position of the first tape on the other side.
6. If you are using one-frame precut tape tabs, follow steps 4 and 5. In this case, however, the four-perforation tab should be applied with two perforations on either side of the cut film end to provide maximum strength. To facilitate centering the tab over the splice, shift the film sections one perforation either way so that the splicer pins may be used for proper registration of the tab. When considering the standard 0.156" (3.96 mm) overlap width, centering the second tab on the other side of the film in a similar manner will displace the tab by the same amount. The result will be two tape ends visible in the picture area in each of the two frames adjacent to the splice (see Figure 9).

Figure 8
One-frame preperforated tape tab.

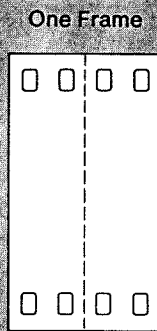

Figure 9 *One-frame tape splice with full hole overlap.*

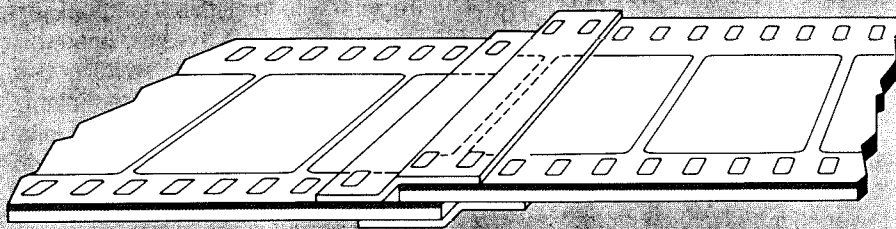

Figure 10
Two-frame preperforated tape tab.

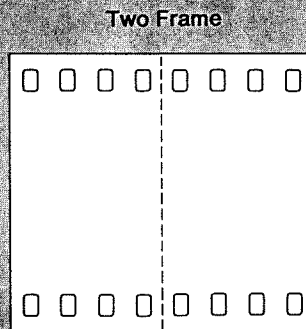
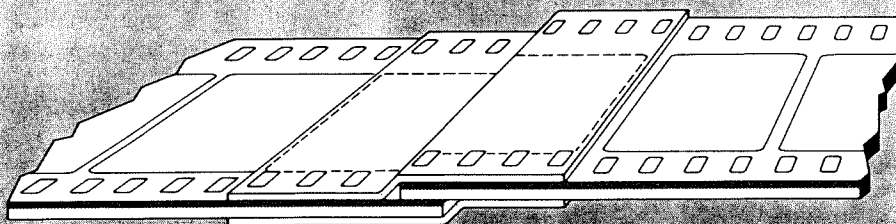

Figure 11 *Two-frame tape splice with full hole overlap.*



Cinemascope Type

Figure 12

Preparation of Cinemascope and wide-screen films for splicing with the Kidde Automatic Splicer.

Wide-Screen Type

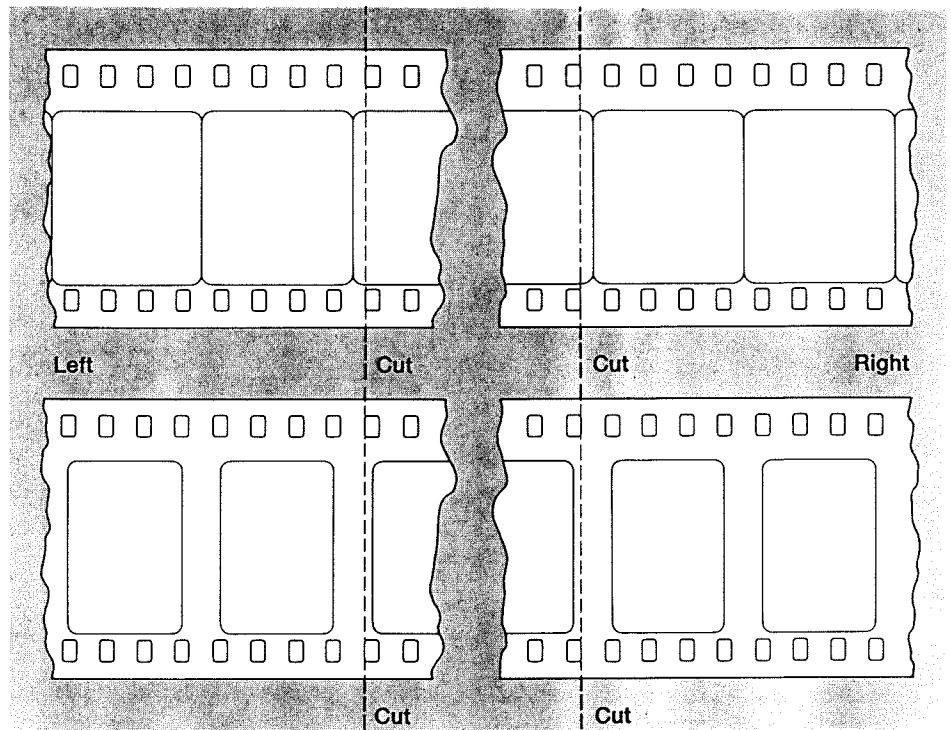

In 35 mm film exchanges or other areas that may be using the Kidde Automatic Splicer, the following directions should be read and carefully observed:

1. Make sure that the machine is switched *OFF* and in the neutral position.
2. Place a small metal plate, or something equally rigid, over the open gap in the splicing area.
3. Cut the two ends of the film to be spliced as illustrated in Figure 12. Use scissors or a small cutting board.
4. Place the two ends of the properly cut film over the alignment pins so that the splice overlap is in frame and near the center between the pins. Bring down the film holding clamp on the right side. If the splicer is equipped with small pins, make sure the edge of the film is aligned, or straight.
5. To make the splice, apply the splicing tape as described in directions 4 and 5 for the bench-top splicer.
6. If you are using one-frame pre-cut tape tabs, shift the two film sections in either direction on the splicer so that the alignment pins can be utilized to register and center the tape tab. In this case, since the overlap is narrower, each tab can be applied to coincide with the other without the displacement necessary when using a bench-top splicer.

A butt tape splice may be considered somewhat superior to an overlap tape splice only because it is less noticeable on the screen. A properly made butt splice depends on a precise cut on both film sections. The two cut edges must mate perfectly and be held in rigid contact while the splicing tape is applied to both sides. If either of these requirements is not met, the splice will be prone to hinging or collapse during projection. Butt splices cannot be readily made on the splicers most commonly found in theaters and film exchanges. The precise cutting and rigid holding of the film sections that are necessary while the splicing tape is applied cannot be accomplished with such splicers. By manipulation, it is possible to cut the film so that the sections will butt in frame, but the quality of the cut will generally preclude a successful splice. Also, the lack of a means to hold the film tightly together at the butt while the tape is being applied further lessens the chances for a successful splice. If butt splicing is desirable, it is strongly recommended that you acquire a splicer specifically designed for that purpose.

Among the bench-top splicers that can make a proper butt splice is the Guillotine Film Splicer, FGU-013, shown in Figure 7. The Guillotine splicer uses unperforated tape, which is perforated as the splice is completed. This splicer can make only butt splices.

Regardless of the instructions, which

may accompany a butt splicer (except Guillotine), it is recommended that a two-frame (eight perforation) tape section be used to make the splice. If one-frame pre-cut tabs are being used, it is obvious that they need not be displaced when applied because no overlap is present.

No matter which type of tape splice you employ, it is important that the film surfaces in the area of the splice be clean and free of oily deposits. Dirt will cause bubbles and blemishes while oily film will prevent proper adhesion. If a tape splice is not aligned properly or produces wrinkles, carefully lift a corner with a razor blade or knife and peel the tab off; then replace it with a new tab. If you are splicing film with magnetic sound tracks, it might be desirable to use a one-frame tab on the track side to minimize sound interruption.

IMPORTANT: *Do not apply tape in the picture area only!* The protruding corners of the film edge could catch at a sprocket pad roller and cause damage.

In review, it is important in all phases of splicing, whether cement or tape, 70 mm or 8 mm, that strict attention be given to cleanliness, technique, and splicing materials. Relaxation in any of these areas can cause film performance difficulties, possible film damage, and interruption of the presentation.