

# FILM-TECH

**THE INFORMATION CONTAINED IN THIS ADOBE ACROBAT PDF FILE IS PROVIDED AT YOUR OWN RISK AND GOOD JUDGMENT.**

**THESE MANUALS ARE DESIGNED TO FACILITATE THE EXCHANGE OF INFORMATION RELATED TO CINEMA PROJECTION AND FILM HANDLING, WITH NO WARRANTIES NOR OBLIGATIONS FROM THE AUTHORS, FOR QUALIFIED FIELD SERVICE ENGINEERS.**

**IF YOU ARE NOT A QUALIFIED TECHNICIAN, PLEASE MAKE NO ADJUSTMENTS TO ANYTHING YOU MAY READ ABOUT IN THESE ADOBE MANUAL DOWNLOADS.**

**[WWW.FILM-TECH.COM](http://WWW.FILM-TECH.COM)**

KODAK  
PAGEANT  
Sound Projector  
Magnetic Optical  
MODEL AV-12M6



# Specifications

**Dimensions in inches:**  
TOP VIEW

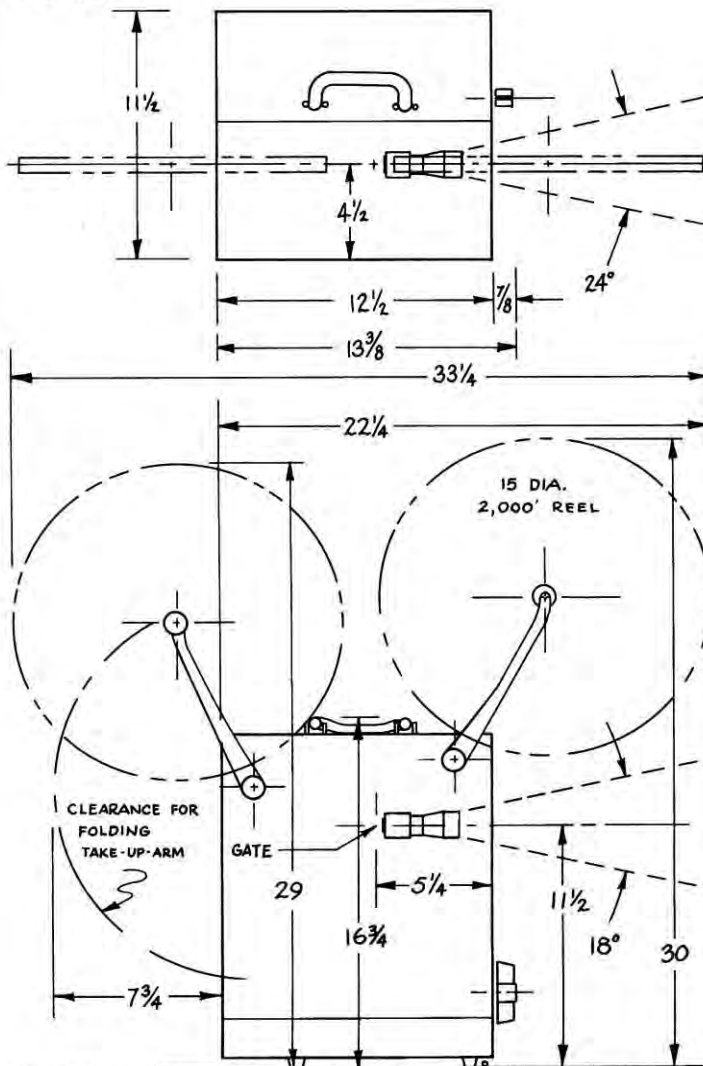

**Reel Size**—maximum 2000-foot

**Elevation**—maximum 2 inches, front control

**Weight**—35½ lbs.

**Note:** Do not obstruct air intake and exhaust areas of the projector (top).

**Power Service Required:**

105- to 125-volt, 60 Hz.

**Power Consumed by Projector and Amplifier on 115-Volt Power Line:**

- 950 watts with a 750-watt projection lamp
- 1200 watts with a 1000-watt projection lamp
- 1400 watts with a 1200-watt projection lamp

**Projection Lamps:**

Suitable lamps for this projector have a medium pre-focused base, 115-volt, T-12 bulb, C-13D filament. They are coded as follows:

ANSI Code	Watts	Hour-Rated Life
DHT	1200	10
DFD	1000	10
DDB (supplied with projector)	750	25
CZX/DAB*	500	25
CXY*	300	25

\*Usually employed where projector is confined to small area or when projector is used to record sound.

**Amplifier (completely transistorized):**

Rating (IHF Specifications A-201 1966)—

**Music Power:** 12 watts

**Sensitivity:** 1mV film channel (equalized)

1mV microphone channel

500mV phono channel

**Distortion:** 2% maximum

**Frequency Response:** 30 to 20,000 Hz ±3db

**Hum and Noise:** -50db

**Preamp:**

Can be used to monitor record and playback sound by employing a set of low-impedance headphones.

**Nominal impedance output:** 200 ohms

**Magnetic Head:**

**Head Gap:** 0.00025 inch

**Nominal electrical characteristics:**

dc resistance—10 ohms

inductance—12mH

**Magnetic Record/Playback Response:**

**Frequency Response:** 70 Hz to 5 KHz ±1db

TYPICAL MAGNETIC RECORD/PLAYBACK CHARACTERISTIC

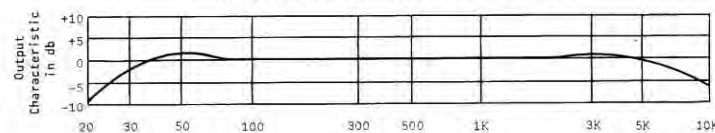

**Tone Control:**

TYPICAL TONE CONTROL TREBLE BOOST/ATTENUATE CHARACTERISTIC

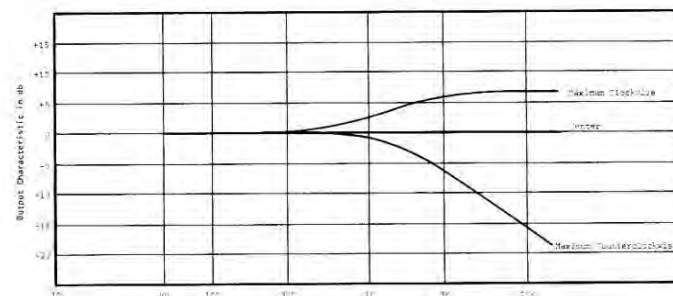

**Speaker:**

11 x 6-inch oval, PM, 6-ohm voice coil

**Exciter Lamp:**

ANSI Code BSK, 6-volt, 1 amp, T-5 bulb, single-contact, medium pre-focused base

**Sound Pickup:**

Silicon solar cell

# Contents

Specifications	2
Setting Up	5
Seating Arrangements	6
Screen • Lamp • Lens Combinations	6
Preparation for Threading	7
Threading for Sound or Silent Pictures	7
Alternate Threading for Silent Pictures	8
Check Setup and Run the Show	8
Sound Optics	10
Rewinding	10
After the Show	10
Microphone • Phonograph • Tape Recorder	11
KODAK SUPER-40 Shutter	12
Operating Tips	13
Recording	14
Microphone • Phonograph • Tape Recorder	14
Mixing (Microphone • Phonograph/Tape Recorder)	15
Recording Tips	15
Replacing Projection Lamp	16
Cleaning Lenses	16
Cleaning Film Gate	16
Cleaning the Sound Optics, Magnetic Sound Heads, and the Film Support Shoe	17
Cleaning Sound Drum	17
Oiling	17
Replacing Belts	18
Replacing Fuse	18
Replacing Exciter Lamp	18
Accessories	19
Service Facilities	19

## SERIAL NUMBER

The serial number is stamped on the nameplate above the PLAY/RECORD SWITCH on the amplifier control panel (see Figure 1). Make a record of this number and keep it in a safe place. The serial number should be included in any correspondence about the projector.

## NOTE

Carefully read and follow the operating instructions presented in this manual. After a preliminary reading of the instructions, practice threading, projecting, and rewinding with a reel of sound film so that you acquire an easy familiarity with the machine before the first show.

## *How to Use the* **KODAK PAGEANT Sound Projector Magnetic/Optical MODEL AV-12M6**

The KODAK PAGEANT Sound Projector, Magnetic/Optical, Model AV-12M6, will project a 16mm film with magnetic or optical (photographic) sound track, or a silent 16mm film. Also, the projector can record sound on a 16mm film to which a magnetic stripe has been applied, such as the KODAK SONOTRACK Coating. While double-perforated film with a narrow magnetic sound stripe (0.030 inch) along one edge can be used, single-perforated film with a wide magnetic stripe (0.100 inch) will give better results. The microphone, supplied with the projector, can be used to record voice on a

magnetically striped film. In addition to the microphone input, a phono input is provided with a separate level control to enable the user to record from a phonograph, tape recorder, radio, or other source. Also, the projector has a preamp output, extending the versatility of the amplifier such as enabling the user to insert a set of low-impedance headphones to monitor sound while recording. The complete system (amplifier, microphone, speaker) can be used as a public address system, as well as for background music or narration with a silent film.

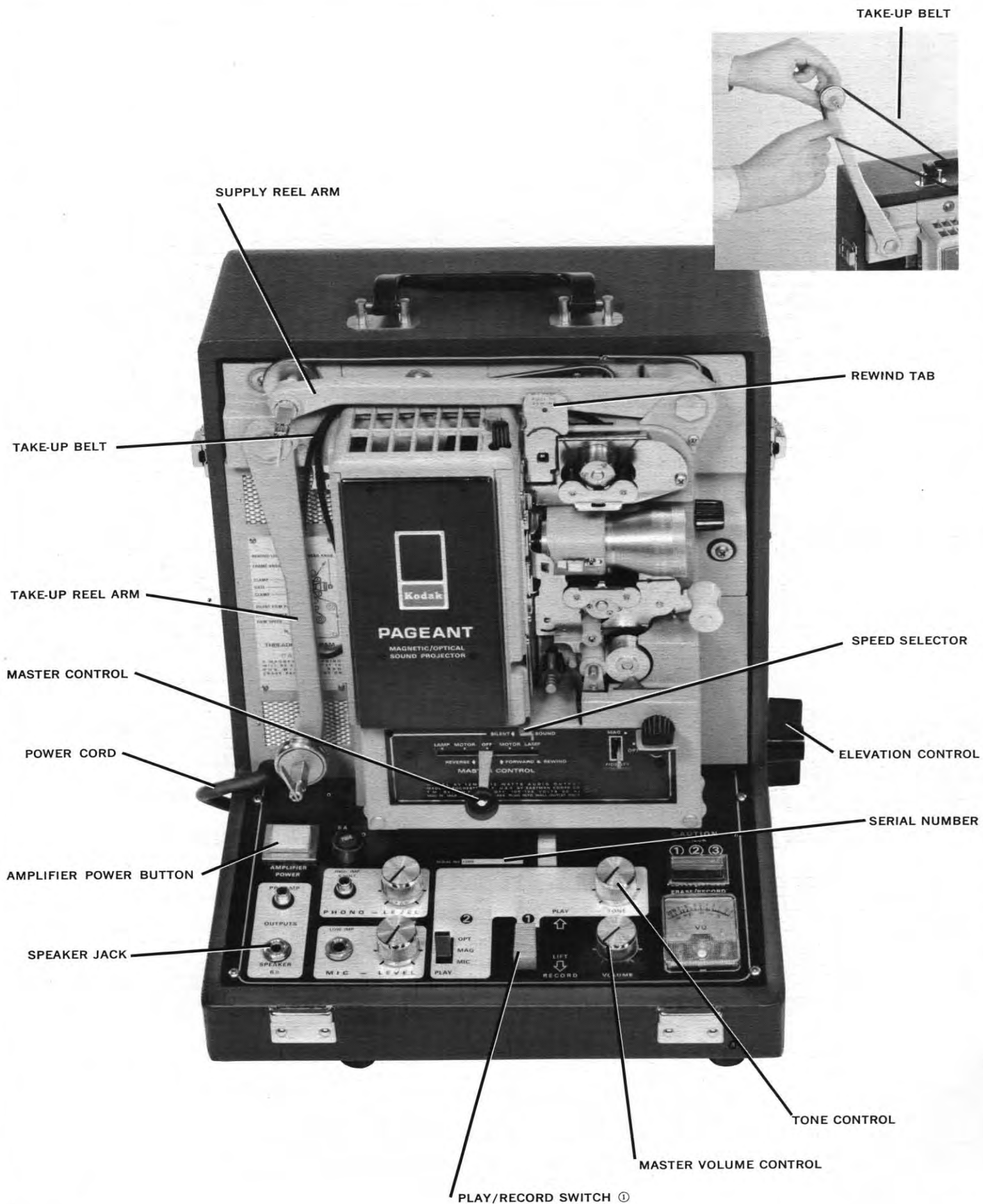

FIGURE 1

## Setting Up

Place the projector on a firm table or other support of convenient height. Set up the projection screen. Be guided as to the relative location of the projector and screen by the information on page 6. Unlatch the cover locks, tilt the cover away from the projector and lift it off.

Remove the POWER CORD from its storage space in the cover and insert its plug into a suitable receptacle. This projector is equipped with a 3-wire power cord and a 3-prong polarized plug for direct connection to a 105- to 125-volt, 60 Hz wall receptacle of the grounding type. By using a suitable power cord adapter, it is possible to plug into a conventional wall receptacle. When you do this, connect the grounding wire attached to the 2-prong adapter to a suitable ground. For convenience, it is suggested that in those locations where the projector will be used frequently, the usual 2-prong receptacle be replaced with a 3-prong polarized receptacle, properly grounded.

If an extension power cord is used, be sure that it has adequate current-carrying capacity (No. 16 AWG wire or larger) to avoid overheating the cord. Use as short a cord as possible to

prevent excessive voltage drop.

Position the speaker as close to the screen as you can. Uncoil enough SPEAKER CABLE (Figure 2) to connect the plug to the SPEAKER JACK (Figure 1) in the amplifier. The speaker should be placed at the ear level of the audience for proper sound distribution.

Lift the SUPPLY REEL ARM up as far as it will go. Lift the TAKE-UP REEL ARM until the TAKE-UP BELT can be put on the take-up pulley. Do not twist the belts. *When projecting film on 50-foot or 100-foot reels, or film on reels with cores smaller than two inches in diameter, remove the belt from the supply pulley.* With these smaller reels, allow the belt to rest between the pulley and the arm. (The belt should be replaced on the pulley when the projector is run in reverse or when film is being rewound.)

Make sure that the REWIND TAB is up, as shown in Figure 1, then turn on the motor and lamp by moving the MASTER CONTROL all the way toward the front of the projector. Rotate the lens clockwise or counterclockwise until the margins of the lighted area on the screen are in focus.

Adjust the elevation by turning the ELEVATION CONTROL clockwise until

the lighted area is centered on the screen.

*While the projector is running forward, move the SPEED SELECTOR to SILENT or SOUND, depending upon the film being projected.\* To move the selector from SOUND to SILENT, push the lever to the left as far as it will go, then turn the motor off momentarily, unless the shutter has been locked in the 3-blade position as shown in Figure 12. (See KODAK SUPER-40 Shutter, page 12.) To go from SILENT to SOUND, push the selector upward to release it—the selector will automatically move to the sound position.*

Turn off the projection lamp and the motor. Turn the MASTER VOLUME CONTROL fully counterclockwise and the TONE CONTROL to FLAT.

Next, turn on the amplifier by momentarily depressing the AMPLIFIER POWER BUTTON; there will be a red glow in the button. Make sure that the PLAY/RECORD SWITCH (numbered ①) is at PLAY.

\*Usually the projection of silent film is at 18 frames per second and the projection of sound film is at 24 frames per second, but sound should be recorded and projected at the speed at which the film was exposed in the camera.

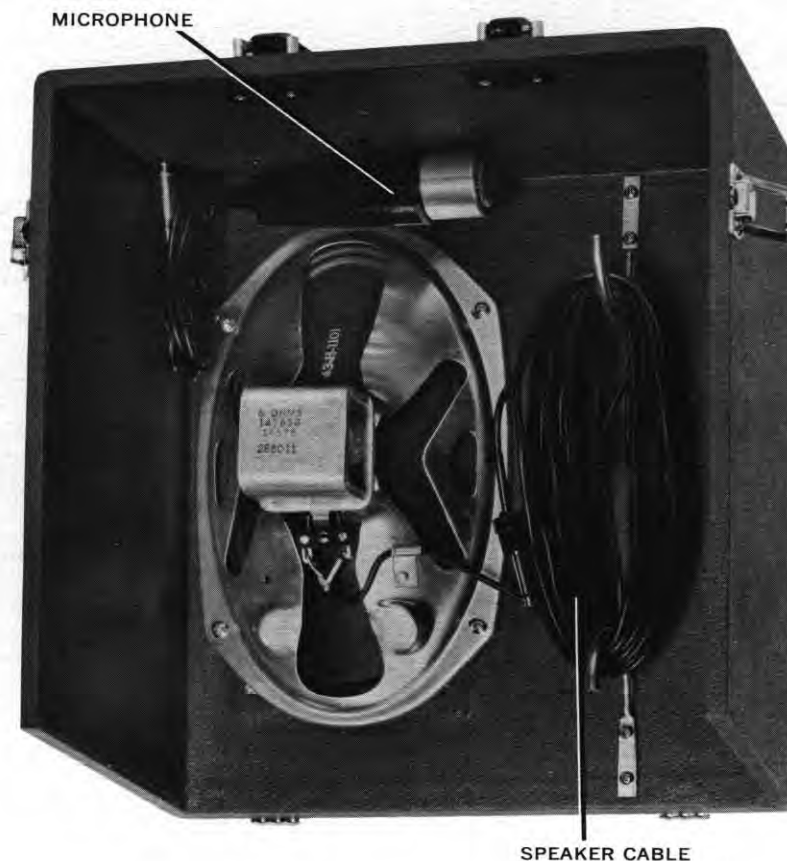

FIGURE 2

SPEAKER CABLE

# Seating Arrangements

## Matte or Lenticular Screen

The diagram directly below shows the best viewing area for matte and lenticular screens.

The seats nearest the screen should not be closer than twice the height of the picture ( $2H$ ); the rear seats should not be farther than 8 times the height of the picture ( $8H$ ).

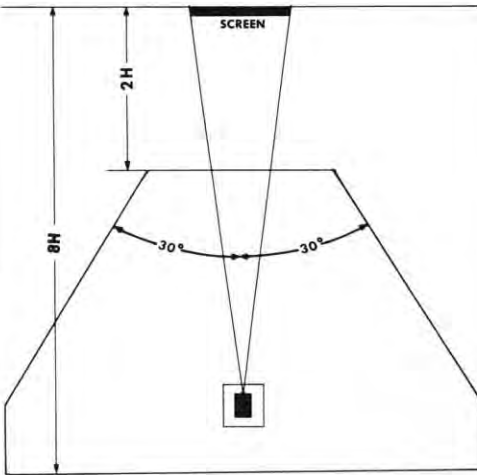

## Beaded Screen

The diagram below shows the best viewing area for beaded screens.

The seats nearest the screen should not be closer than  $2\frac{1}{2}$  times the height of the picture ( $2\frac{1}{2}H$ ); the rear seats should not be farther than 8 times the height of the picture ( $8H$ ).

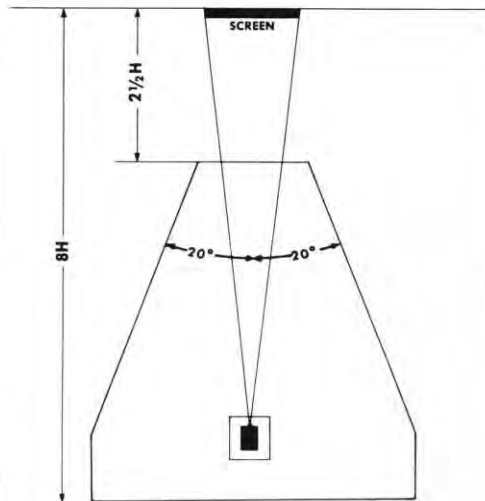

# Screen • Lamp • Lens Combinations

Proper selection of screen, lamp, and lens for your particular setup is important. The screen image should be of adequate size and brilliance for comfortable viewing. With the wide variety of lamps and lenses available for your PAGEANT Projector, you can tailor your equipment to meet this requirement.

The chart shows the relation between projection distances and screen sizes for each of the currently available lenses. It is best to use a lens that provides a screen image of a height that is not less than one-eighth of the distance from the screen to the back row of seats. If the image is smaller than this, the viewers in the back rows

will not be able to see the fine detail in the pictures.

Make sure that the screen image is neither too bright nor too dark. If it is too bright, flicker may become objectionable; if too dark, detail will be lost in the shadow areas of the pictures.

Shown in the table are the maximum image widths or heights for adequate illumination on matte screens and on lenticular or beaded screens with those lamps recommended for use. These maximum widths or heights are for good projection conditions in a darkened room; they will have to be somewhat less if there is much stray light in the room.

Projection Lamp Wattage	Maximum Image Width or Height in Inches in a Darkened Room							
	Shutter in 3-Blade Position				Shutter in 2-Blade Position			
	Matte Screen		Lenticular or Beaded Screen		Matte Screen		Lenticular or Beaded Screen	
	W	H	W	H	W	H	W	H
750	60	45	85	64	70	53	100	75
1000	70	53	100	75	80	60	120	90
1200	75	56	110	83	90	68	130	98

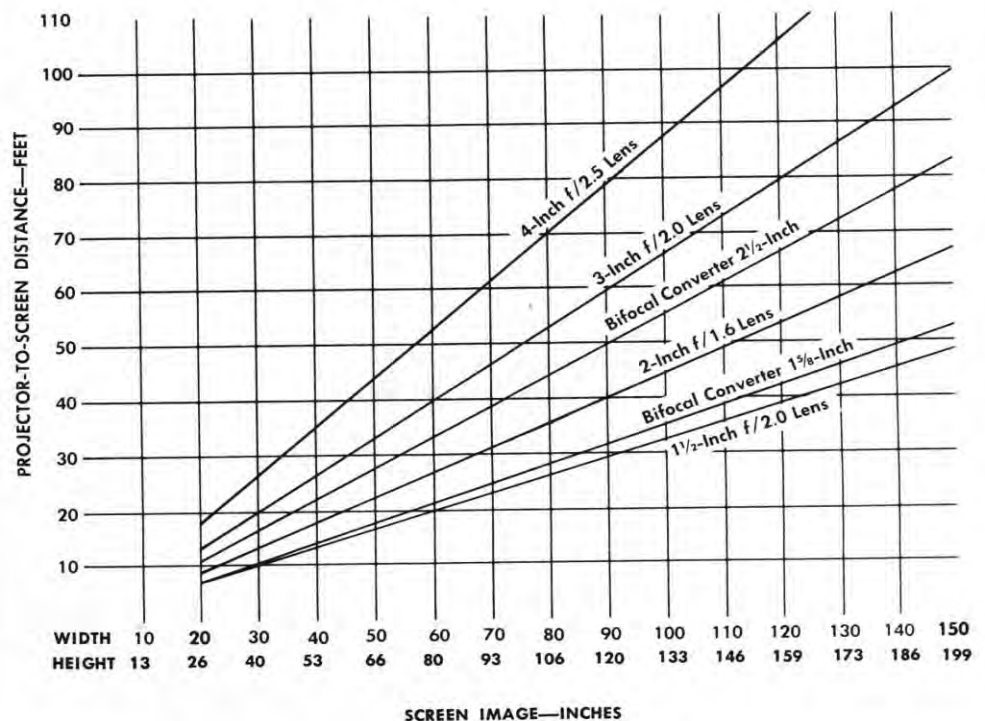

# Preparation for Threading

Place the reel of film on the SUPPLY SPINDLE (Figure 3) with the film feeding clockwise off the reel and the perforations toward you. Lock the reel onto the spindle with the LATCH. Place an empty reel on the TAKE-UP SPINDLE and lock it in place.

Make sure that the rewind tab is latched in the vertical position.

Check to see that the speed selector is properly set for the film to be projected.

Make sure the MAGNETIC/OPTICAL HEAD POSITION SWITCH (numbered ③) is at OPTICAL. This position moves the magnetic heads away from the film channel.

Open the feed and take-up sprocket CLAMPS.

Open the GATE by pushing forward on the tab until it latches.

Turn the THREAD KNOB until the white line on the knob is toward the lens. With the knob in this position, the pulldown claw will be withdrawn from the film channel.

# Threading for Sound or Silent Pictures

Draw off about five feet of leader. Grasp the leader near the supply reel and insert it between the feed sprocket and clamp, engage the perforations with the sprocket teeth, and close the clamp. (See Figure 4.)

Place the leader between the top and bottom EDGE GUIDES of the film channel. Close the gate by pressing on the GATE LATCH. Form the upper loop to the red dot on the REWIND TAB.

Thread the leader under the LOOP-FORMING ROLLER. The leader should

just touch the roller (*not* as shown in Figure 4).

Pull back the sound drum PRESSURE ROLLER and place the leader over the roller and under the SOUND DRUM. *The magnetic/optical head position switch ③ must be at OPTICAL for threading.* Release the roller, making sure that the leader is between the flanges.

Pass the leader to the left of the DAMPER ROLLER and between the take-up sprocket and clamp. Engage the

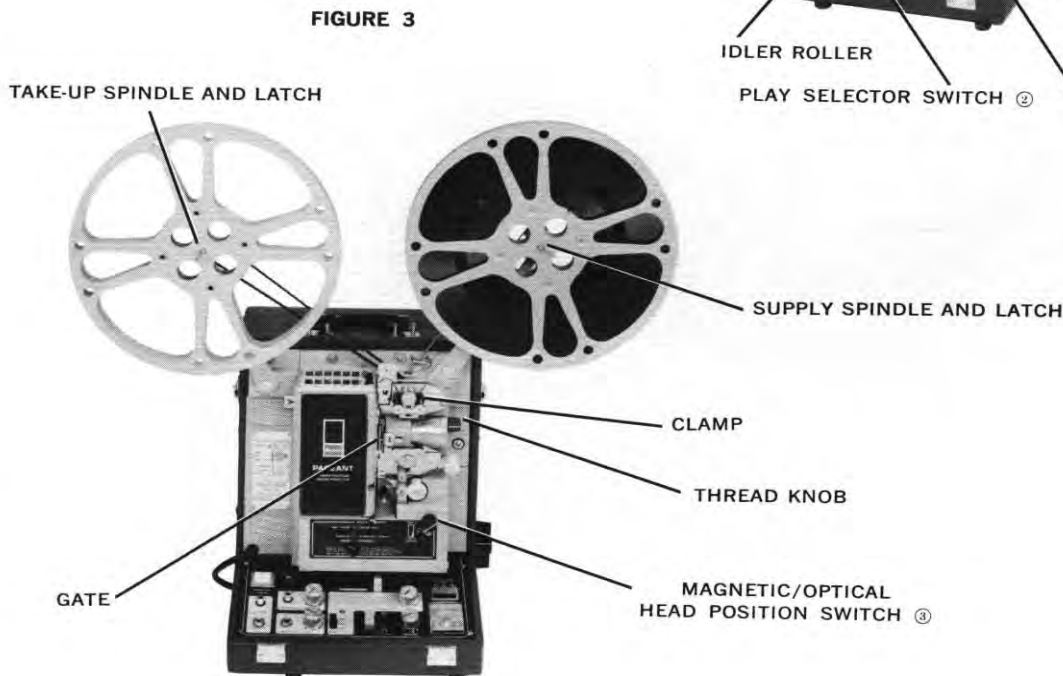

FIGURE 3

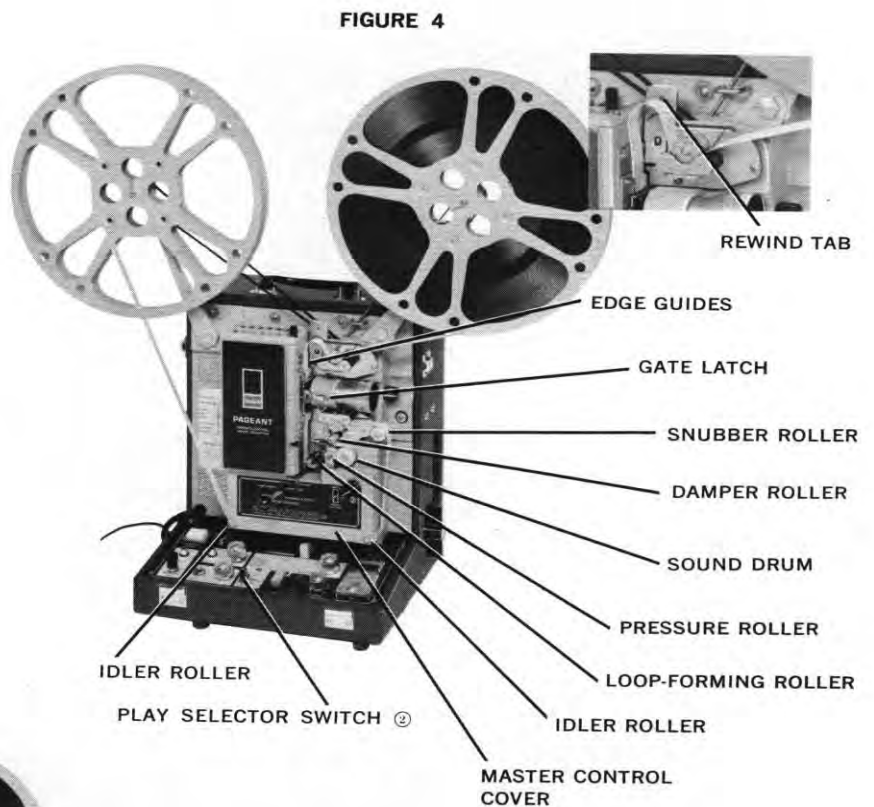

FIGURE 4



perforations with the sprocket teeth and close the clamp. Make sure that the leader is against the damper roller.

Press down the loop-forming roller as far as it will go and then release it. This action will correctly position the upper and lower loops as shown in Figure 4. *When sound film is being projected, the loop-forming roller properly positions the film between the gate and the sound head.* Turn the thread knob until the pulldown claw engages the leader perforations. Figure 4 shows the positions of the clamps, gate, and leader *after* the loop-forming roller has been pressed down and released.

Bring the leader over the SNUBBER ROLLER and under the two IDLER ROLLERS on the bottom of the MASTER CONTROL COVER. Insert the end of the leader into the slot in the core of the take-up reel. Remove any slack between the take-up sprocket and the take-up reel.

*For sound projection only:* Turn on the amplifier and set the magnetic/optical head position switch ③ and the PLAY SELECTOR SWITCH (numbered ②) for the type of film to be projected. Make sure the play/record switch ① is at PLAY.

If the magnetic/optical head position switch ③ is inadvertently set at MAGNETIC when an optical sound track is to be reproduced and the play selector ② is set at OPT the amber warning lamp will appear on the control panel indicating that you must check the *three* numbered switches.

*For silent projection only:* Turn off the amplifier and set the magnetic/optical head position switch ③ at OPTICAL and the play/record switch ① at PLAY. While the projector is running forward, set the speed selector at SILENT. Be sure to turn the motor off momentarily after changing from sound to silent speeds unless the shutter has been locked in the 3-blade position as shown in Figure 12. (See KODAK SUPER-40 Shutter, page 16.)

**Note:** Project at SILENT; rewind at SOUND.

## Alternate Threading for Silent Pictures

Draw off about five feet of leader. Insert the leader between the feed sprocket and clamp, engage the perforations with the sprocket teeth, and close the clamp. (See Figure 5.)

Place the leader between the top and bottom edge guides of the channel. Form the upper loop as shown and close the gate by pressing on the gate latch.

Form the lower loop as shown and thread the leader between the take-up sprocket and clamp. Engage the perforations with the sprocket teeth and close the clamp.

Turn the thread knob until the pulldown claw engages the leader perforations.

Pass the leader over the snubber roller and under the two idler rollers on the bottom of the master control cover. Insert the end of the leader into the slot in the core of the take-up reel. Take up the slack between the lower sprocket and the take-up reel.

While the projector is running forward, set the speed selector at SILENT. Be sure to turn the motor off momentarily after changing from sound to silent speeds unless the shutter has been locked in the 3-blade position as shown in Figure 12. (See KODAK SUPER-40 Shutter, page 12.)

**Note:** Project at SILENT; rewind at SOUND.

## Check Setup and Run the Show

Make sure the sound controls are set at the proper positions. Turn the thread knob clockwise a few times to check the threading. The pulldown claw must engage the perforations and the sprockets must feed the film.

The loops must be maintained in their correct sizes. The leader should be taut between the supply reel and the upper sprocket.

Move the master control to MOTOR (forward) and check to see that the film is running through properly.

Move the master control to LAMP. Focus the image on the screen.

Turn the FRAMING SCREW (Figure 5) to eliminate any frame line at the top or bottom of the screen image.

*For sound film only:* Adjust the volume control to provide comfortable listening for the audience. If the sound track is optical, set the tone control at FLAT; focus the sound optics to get the best high frequency response by moving the FIDELITY CONTROL up or down. Then readjust the tone control.

Check to see that the film is being taken up properly.

Check the lower loop. If necessary, depress and release the loop-forming roller. This may be done with the projector running, if desired.

*To operate the projector in reverse,* move the master control to REVERSE, MOTOR and, if desired, to REVERSE, LAMP. When reversing magnetic-striped film, set the magnetic/optical head position switch ③ at OPTICAL. This will avoid having splices bump the head and will prevent erasure of any previously recorded sound.

After the last frame of sound film has been projected, turn off the amplifier by momentarily depressing the amplifier button; also turn off the lamp. This will eliminate the sounds that occur when the end of the film is feeding through the projector.

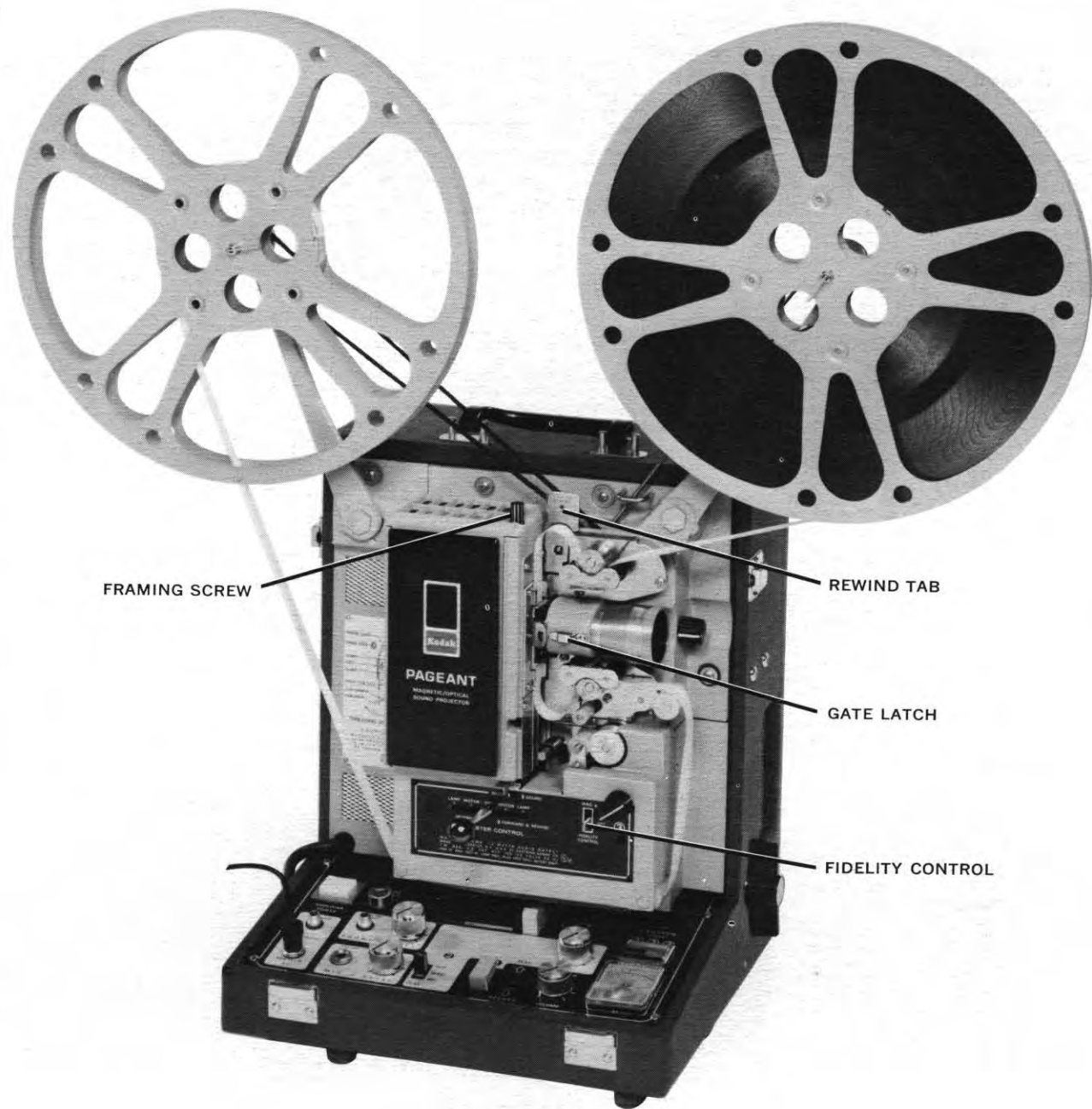

FIGURE 5

# Sound Optics

When films with optical sound tracks are being projected, focusing the beam of light from the exciter lamp is extremely important; it is accomplished by adjusting the fidelity lever. Adjustment is made by moving the lever up or down, then leaving the lever at the position that provides the highest pitched sounds. The sound track, running along one edge of the film, can be on either surface of the film, depending upon what type of film is being used.

Figure 6 illustrates the proper position of the beam for each of the two types of film: one threaded with the emulsion side on top and away from the sound optics (A), and the other with the emulsion side on the bottom and toward the sound optics (B).

FIGURE 6

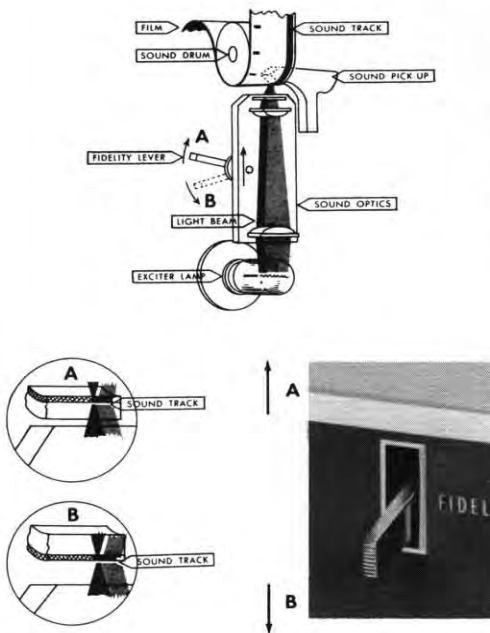

# Rewinding

To rewind the film, attach its end directly to the supply reel and give the reel a few turns counterclockwise to bind the film. (See Figure 7.)

Make sure that the film is not twisted between the reels.

Move the master control to FORWARD & REWIND.

Lower the REWIND TAB to its horizontal position; the tab will block the film channel.

Set the speed selector at SOUND; this is necessary for all rewinding.

After all the film has been rewound onto the supply reel, set the rewind tab in the vertical position and move the master control to OFF.

FIGURE 7



# After the Show

Following the projector and rewinding of all reels of film that are to be shown:

Unplug the speaker cable and wind it around its storage hooks.

Unplug the power cord and wind it around the same storage hooks used for the speaker cable.

Remove the take-up belt from the take-up pulley. Raise the take-up arm slightly, push in the TAKE-UP ARM RELEASE (Figure 8), and lower the arm to its storage position. Swing the supply arm downward to the rear of the projector as far as it will go.

Lower the projector by turning the elevation control counterclockwise as far as it will go.

Replace and fasten the projector cover.

FIGURE 8

TAKE-UP ARM RELEASE



# Microphone • Phonograph • Tape Recorder

Before you use the microphone or the phonograph input (the tape recorder output plug can be inserted into this connector) on the projector, make sure the three sound position switches ①, ②, and ③ are all set at the recording or the playback positions (Figure 9).

*Microphone for P. A. System with Silent Pictures*—(For use in magnetic sound recording, see *RECORDING*, page 14) Insert the microphone plug into the MICROPHONE JACK. Make sure the plug is all the way in. Turn the magnetic/optical head position switch ③ to OPTICAL and set the play selector switch ② to MIC. Insert the speaker plug into its jack. Depress the amplifier power button to turn on the amplifier. Adjust the level, volume, and tone controls. (The microphone volume is regulated by both the master volume control and the MICROPHONE LEVEL CONTROL.)

*Phonograph (or Tape Recorder) for P. A. System or Background Music with Silent Pictures*—(For use in magnetic sound recording, see *RECORDING*, page 14) Connect your record player or tape recorder by inserting its plug into the PHONO JACK. The plug must be all the way in. *The output volume is dependent upon the settings of the master volume control and the PHONO LEVEL CONTROL on the projector.* Also, level or volume controls on the phonograph or tape recorder will have a bearing on the output volume. Flat frequency response of the amplifier will be obtained when the tone control is at FLAT.

**Note:** The phonograph input of the projector is high impedance to match crystal or ceramic phonograph pickups; it will also accept the output of a preamplifier, which must be used if the phonograph pickup is of the magnetic type.

The microphone input is designed for use with a low-impedance dynamic microphone. Also, the shield of the microphone cable is the grounded side of the microphone, so the signal is fed through the tip of the  $\frac{1}{4}$  inch phone-type plug.

FIGURE 9

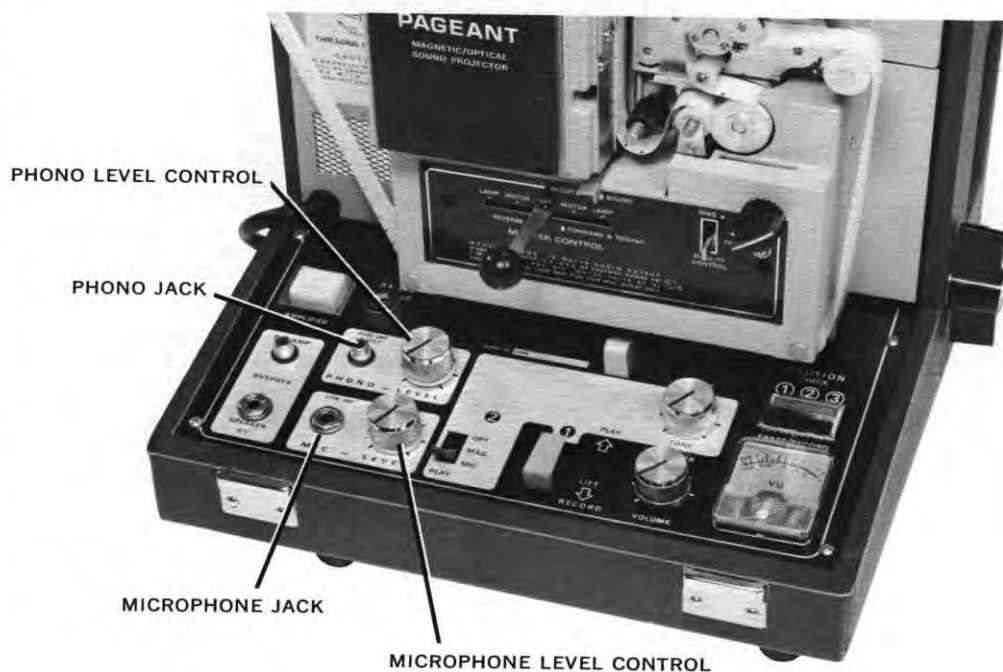

# KODAK SUPER-40 Shutter

The Model AV-12M6 Projector is equipped with the SUPER-40 Shutter (Figure 10), which provides 40 percent more screen illumination in the 2-blade position than it does in the 3-blade position.

## Action of the SUPER-40 Shutter

At the 3-blade position (for silent speed), there are a minimum of forty-eight light interruptions per second. This position is maintained by spring tension. The tension counteracts the centrifugal force exerted by a weight that is linked to the two MOVABLE BLADES.

When the speed selector is moved to SOUND, the additional centrifugal force that results from the faster speed of the shutter overcomes the spring tension. The movable blades rotate on their axis and overlap in a

position opposite the FIXED BLADE. Now the shutter will operate in the 2-blade position, giving the same light interruptions per second, but with 40 percent more screen illumination.

**Sound Speed**—If the SUPER-40 Shutter in the 2-blade position provides too much illumination, it can be locked in the 3-blade position. When the projector is operated at sound speed, the shutter will automatically shift (if not locked) from the 3-blade position to the 2-blade position.

**Silent Speed**—The SUPER-40 Shutter will remain in the 3-blade position if the projector is started in silent speed. If the projector is started in sound speed and then shifted to silent speed, the shutter cannot return to the 3-blade position unless the motor is stopped momentarily.

## Locking the SUPER-40 Shutter in the 3-Blade Position

Stop the projector; loosen the SCREW on the LAMPHOUSE COVER (Figure 11); remove the cover. Turn the thread knob until the SHUTTER LOCK (Figure 12) is visible. Hold the thread knob to prevent rotation of the shutter and, using a screwdriver or similar object, push the shutter lock *down* as far as it will go. Replace the lamphouse cover and tighten the screw. To unlock the shutter, proceed as above, except that the shutter lock must be moved *up* as far as it will go.

FIGURE 10

SHUTTER LOCK



SUPER-40 SHUTTER IN 2-BLADE POSITION

FIXED BLADE    MOVABLE BLADE



SUPER-40 SHUTTER IN 3-BLADE POSITION

FIGURE 11

LAMPHOUSE COVER

SCREW

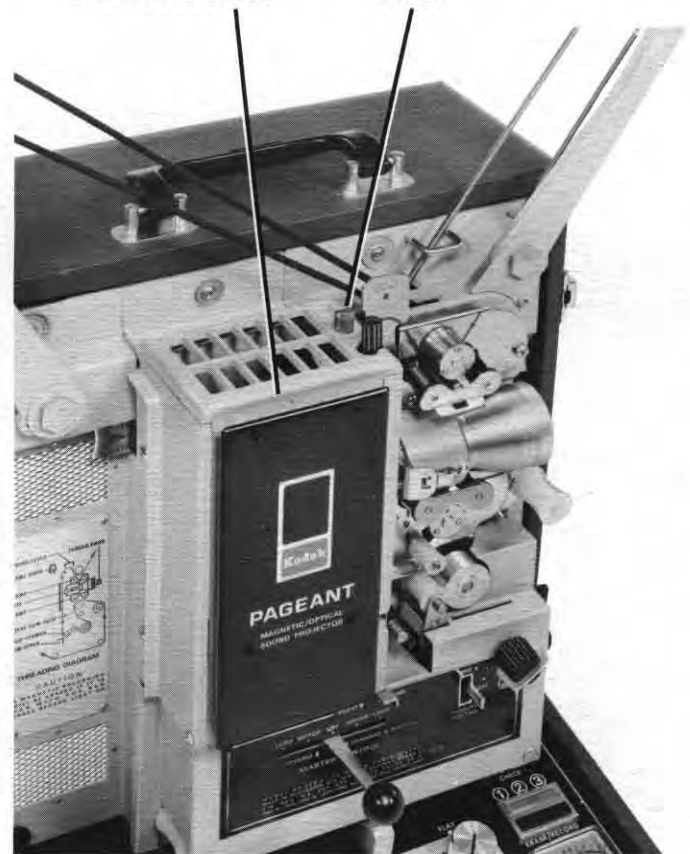

## Operating Tips

The perforations in the film should be toward you as film comes off the bottom of the supply reel. If they are not, the film has not been rewound or was twisted while being rewound.

If the gate is left open, the projected picture will be out of focus.

To achieve uniform brightness of the screen, check to be sure that the lamp is firmly in its socket and locked in place, then adjust the LAMP CENTERING SCREW (Figure 12) without film in the gate.

If the picture is unsteady, check the upper and lower loops; these must be maintained. The lower loop should not touch the master control cover nor the loop-forming roller. The sprocket teeth must show through the film perforations. Make sure that the gate and the sprocket clamps are closed.

If loss of loop occurs: threaded for sound or silent projection (page 6)—quickly press down the loop-forming roller as far as it will go and release it while the projector is running; threaded for silent projection, alternate method (page 8)—stop the motor immediately and re-form the loops.

If the projector is stopped during the projecting of a reel of sound film, turn the thread knob several revolutions clockwise to take up any slack between the lower sprocket and the sound drum.

*If there is no sound, check to make sure that:*

- Speaker cord is connected.
- Amplifier is turned on—check amplifier power button, which also acts as an amplifier pilot light.
- Sound track is overriding edge of sound drum properly.
- Film is between the flanges of sound drum pressure roller.
- Exciter lamp is not burned out and is seated on all three studs.
- Sound controls are set at proper positions.
- Fuse is not burned out. (Amplifier power button will not glow if fuse is blown.)

*If the sound quality is not up to par, check to make sure:*

- Speed selector is at proper position.
- Lower loop is of the proper size.
- Film is snug around sound drum and drum is clean.
- Volume is not too high.
- Tone control is correctly adjusted.
- Fidelity lever is adjusted for correct sound optics focus.
- Film sound track is of good quality and clean.
- Sound optics unit has been properly seated after cleaning.
- Sound is synchronized with the picture. If it is not, the cause may be an improperly formed lower loop. To re-form the loop, press down the loop-forming roller while the projector is running.

FIGURE 12

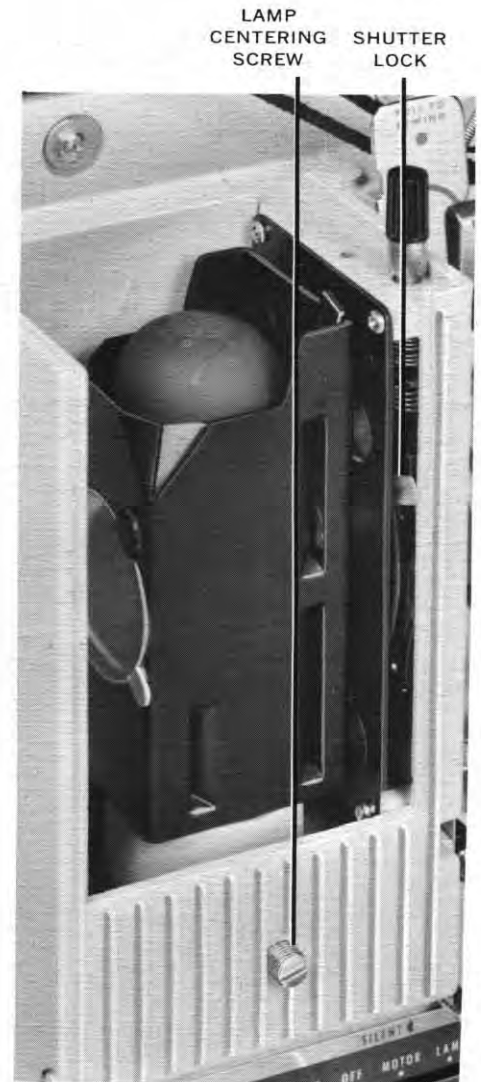

# Recording

Thread the magnetically striped film through the film path of the projector as you would for sound projection (Figure 4).

Set the speed selector at the speed at which the film was exposed in the camera. The recorded sound will automatically be synchronized with the pictures.

**IMPORTANT:** The PREAMP OUTPUT can be used to monitor sound by connecting a set of low-impedance headphones to this jack before recording.

## Microphone Input

Insert the microphone into the MIC JACK (Figure 13). Set the play/record switch ① at RECORD. (Pull up the knob to override the erase lockout, and make sure the switch is all the way toward RECORD; the switch locks in the PLAY position, thus preventing accidental erasure.) Turn on the amplifier and set the level and volume controls at approximately the middle of their scales. (The tone control is inoperative when recording.) Perform a few volume tests to determine the best settings by turning the magnetic/optical head position switch ③ to OPTICAL to avoid accidental erasure and then watching the VU (volume unit) meter while you say a few words and adjust the controls; then return the switch to MAGNETIC. (The VU METER POINTER should barely enter the red part of the scale on the higher pitched sounds.) When the play/record switch ① is at RECORD and the magnetic/optical head position switch ③ is at MAGNETIC, the ERASE/RECORD red light will glow, indicating the projector is in the record position.

**CAUTION:** Do not re-run or reverse film past the sound head with the magnetic/optical head position switch ③ at MAGNETIC because previously recorded sound will be erased.

For narration, hold the microphone several feet from the projector and directed away from it. (A shielded extension cord can be used; obtainable from an electronic supplier.) Position the microphone approximately 3 inches away from the mouth. Read a few lines of the commentary and adjust the volume control until the VU meter barely enters the red area intermittently and on syllables that are emphasized. (The microphone can also be used for pickup of live music or sound effects.) Experimentation will be necessary with the microphone to establish the conditions for best results.

If errors in recording are made, they can be edited out by the following procedure:

1. Move the master control to OFF.
2. Set the play/record switch ① at PLAY and the magnetic/optical head position switch ③ at OPTICAL; then run the projector in reverse to the point at which the error occurred. Play the section that is to be corrected so that you become aware of the place where the correction is to be made.
3. Prepare to rerecord by returning the film to the beginning of the section to be corrected; then set the play/record switch ① at RECORD and the head position switch ③ at MAGNETIC. Check the recording to make sure that the input volume is in the approximate range of the previously recorded sound.
4. Put the control knob at the forward position and after a pause of one or two seconds begin the new recording. (This pause will allow the projector mechanism to obtain its normal speed.)

**Note:** You will find that by experimenting with making corrections, you can rerecord with little or no gap time between the satisfactory sound and the corrected sound portions of the film.

## Phono Input

Insert the phonograph or tape recorder plug into the phono jack (Figure 14). Set the magnetic/optical head position switch ③ at OPTICAL and the play/record switch ① at RECORD (pull up the knob to override the erase lockout, and make sure the switch is all the way toward RECORD; the switch locks in the PLAY position, thus preventing accidental erasure). Turn on the amplifier and set the level and volume controls at approximately the middle of their scales. Test the input volume by watching the VU (volume unit) meter as you play a portion of a record or tape. Adjust the level and the volume controls if you do not receive a satisfactory reading on the meter. For music, the pointer on the VU meter should approach but not enter the red area. When the play/record switch ① is at RECORD and the magnetic/optical head position switch ③ is at MAGNETIC, the ERASE/RECORD red light will glow, indicating the projector is in the record position.

**CAUTION:** Do not re-run or reverse film past the sound drum with the magnetic/optical head position switch ③ at MAGNETIC because previously recorded sound will be erased.

The recorded material will automatically be synchronized with the pictures.

After you have made the volume tests and the controls have been set to the proper positions to record sound, you can begin to record onto the sound track.

If errors in recording are made, they can be edited out by following the procedure explained in the previous section.

**Note:** Recorded music for which clearance or "use rights" can be obtained is available from music libraries. Catalogs from the libraries list titles, themes, moods, and exact playing times. For legal reasons, no music, tape or record should be rerecorded unless it is known to have proper clearance.

# Recording Tips

## Mixing—Microphone • Phonograph • Tape Recorder

If desired, you can record music as a background to a narration.

Connect the microphone and phonograph or tape recorder as previously explained. Set the control knobs as you would for recording a narration.

Read a few lines of narration, adjusting the microphone LEVEL and the phono LEVEL, making sure the latter is less than the microphone LEVEL. Set the magnetic/optical head position switch ③ at OPTICAL and reverse a few feet of the recorded portion of film. Listen to the test recording, and note what adjustments have to be made. Then return all the controls to the proper positions to record. Begin the recording and use the VU meter and the knob pointer positions to guide you in adjusting the volume.

• If pressure-sensitive tape, such as KODAK PRESSTAPE, is used for splicing after the film has been sound-stripped, proceed as follows so that the sound stripe will not be covered: (1) apply tape to the side of the film not sound-stripped as directed in the instructions; (2) *before* applying tape to the sound-stripped side of the film, trim off (with scissors) the edge of the tape that would cover the sound stripe. Continue then as directed in the instructions.

• The magnetic/optical head position switch ③ is spring-loaded to maintain proper contact with the sound stripe. There will be some displacement when cemented splices contact the recording head; to minimize this displacement, splice film as shown in the illustration below.

• To minimize noise pickup by the microphone, use the microphone at full cord length. Rooms having sound-absorbing materials (heavy drapes, thick carpeting, etc) are best suited for recording purposes. Remember that the sensitivity of a microphone is such that it will pick up extraneous sounds—rustling of papers, traffic noises, ringing telephones, footsteps, etc.

• While it is possible to record music as well as speech by placing the microphone in front of the speaker of a radio, phonograph, or tape recorder, it is not recommended. The quality of the sound on the film will not be as high as when a signal from the reproducing device (radio, record player, etc) is fed directly to the phono input of the projector.

• Because a magnetically striped film is thicker than silent film, the normal capacity of the reel is reduced by about 10% when it is used for the former. This fact should be taken into account when editing your film so as not to overload the reel.

• It will be found that maximum speed and ease in magnetic recording will be obtained when two people perform as a recording team. One person attends to the operation of the projector while the other does the narration or takes care of the record player or other source of background music. A third person, acting as a director, could also be helpful.

• Selection of music—the type of music should match the mood and tempo of the motion pictures.

PREAMP OUTPUT



FIGURE 13

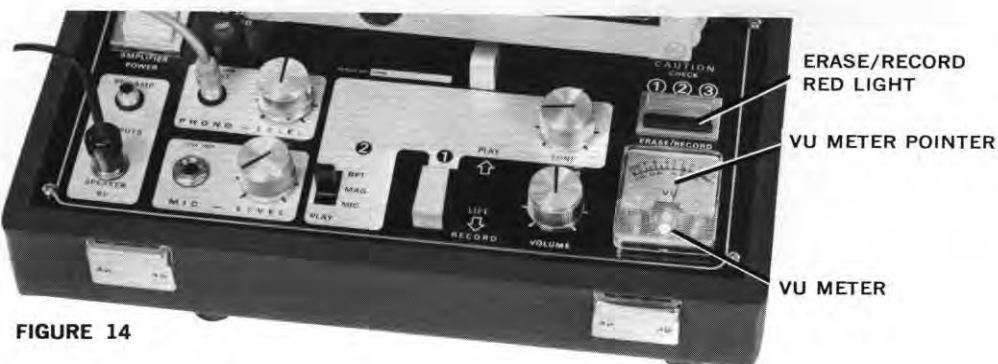
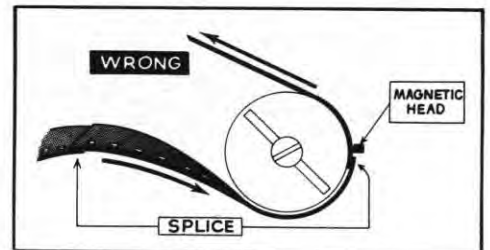
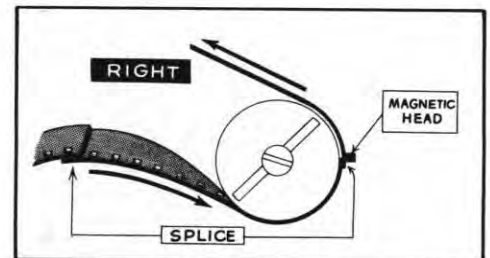

FIGURE 14





# Replacing Projection Lamp and Cleaning Lenses

**Projection Lamp:** Loosen the lamp-house cover screw and lift off the lamphouse cover. (See Figures 11 and 15.)

**WARNING:** High-wattage lamps get very hot in use. Make sure enough time is allowed before you handle the lamp. Cooling can be accelerated by running the projector without film and with the lamp off.

Remove the lamp by pushing it down, twisting it counterclockwise one quarter of a turn, and lifting it out.

Replace the lamp with the larger flange on the lamp base facing toward the projection lens. Push the lamp down and give it a quarter-turn clockwise to lock it in position. Replace the lamphouse cover and tighten the screw.

If necessary, before replacing the cover adjust for evenness of illumination by turning the LAMP CENTERING SCREW with no film in the gate (Figure 16).

**Cleaning Lenses:** The projection and condenser lenses should be cleaned with care. Remove the projection lens by drawing it out of the lens holder.

With a soft, lintless cloth or KODAK Lens Cleaning Paper, carefully wipe the front and rear lens surfaces. Do not use a wet cloth; if moisture is required, breathe on the lens or use a drop of KODAK Lens Cleaner.

**WARNING:** The use of treated papers or cloths can harm the LUMENIZED surface.

To clean the condenser lens and reflector, remove the LAMP (Figure 15), push the condenser lens ARM inward (in the direction of the arrow), and lift out the assembly. Carefully wipe the front and back surfaces of the lenses. If the inside surfaces need cleaning, pry out the RETAINING SPRING and remove the lenses from their housing. Clean both surfaces of each lens. Replace the lenses with the matching curved sides inward. Install the assembly; apply a light pressure toward the film gate while moving the arm outward to lock the condenser-mount ears under the lugs in the lamphousing.

Clean the lamp reflector with a soft, lintless cloth or KODAK Lens Cleaning Paper.

Replace the projection lamp and the lamphouse cover.

# Cleaning Film Gate

The film GATE (Figure 17) should be cleaned at frequent intervals. Because of the rapid stop-and-go motion of the film, particles of the emulsion and lubricant are eventually rubbed off the edges of the film and lodged on the gate; this can damage film.

Use care in removing or replacing the gate; force is not necessary.

To retract the pulldown claw, turn the thread knob until its white line is toward the lens. Remove the projection lens.

Open the gate and insert a clean CARD (approximately 1/16 inch) to protect the polished surfaces of the gate; then withdraw the gate.

Use a soft, damp, lintless cloth to clean the gate. If necessary, wrap the cloth around a toothpick or match stick to clean the film track.

To clean the aperture, reach through the projection-lens holder with a small, soft brush and dust off the edges of the aperture. Be careful not to chip off the black coating on the edges.

Before replacing the gate, make sure the pulldown claw is retracted. Then guide the upper notched part of the gate so that it bears against the under part of the top hinge-retaining SPRING. Push in on the gate tab to engage the top and bottom hinges.

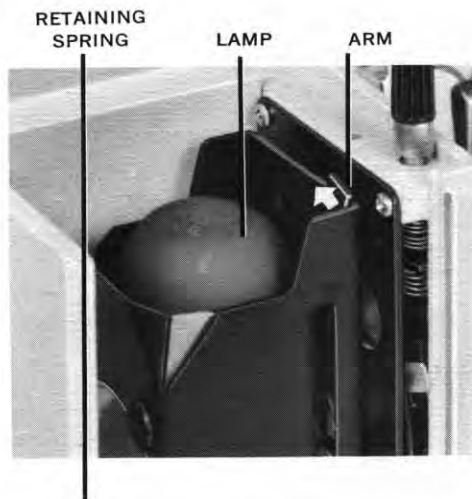

FIGURE 15

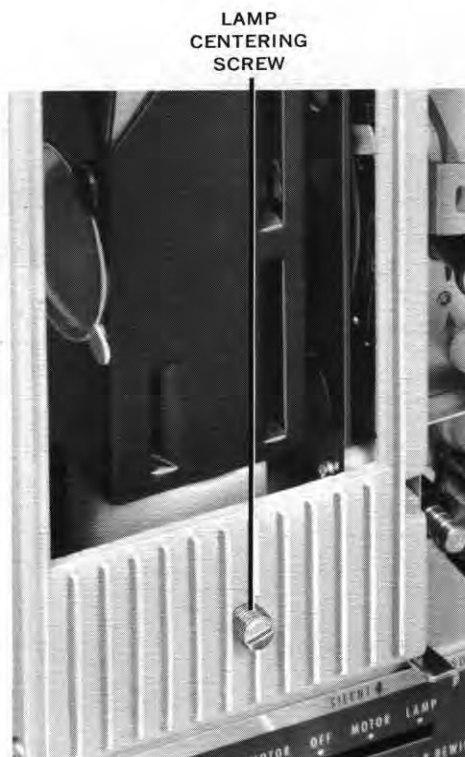

FIGURE 16

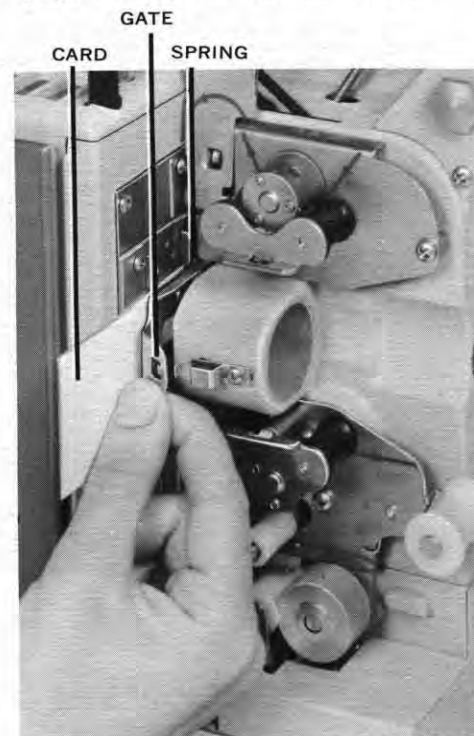

FIGURE 17

## Cleaning the Sound Optics, the Magnetic Sound Heads, and the Film Support Shoe

Occasional cleaning of the sound reproducing components is recommended.

Be sure that the power cord is not plugged in. Remove the three master control COVER SCREWS (Figure 18) and the SPACER. Set the magnetic/optical head position switch ③ to OPTICAL and remove its knob by pulling it off its shaft. Move the master control all the way to the left. Swing the MASTER CONTROL COVER out-

ward for access to the sound optics and exciter lamp. With a soft brush, dust the top and bottom sound optics lenses. The SOUND PICKUP and the FILM SUPPORT SHOE (Figure 19) are just above the upper SOUND OPTICS LENS and directly behind the sound drum. The surface of these parts should be kept clean by using a soft brush. Be sure the optics unit is properly seated. Replace the master control cover and the knob.

## Cleaning Sound Drum

The sound drum, sprocket-clamp rollers, and other rollers that come in contact with the film should be wiped occasionally with a soft, lintless cloth to keep them clean. Dirt particles on the inner edge of the sound drum will interrupt the light beam and cause blips and hum. To check for this condition, empty the projector and run it in reverse with the amplifier on and the magnetic/optical head position switch ③ at OPTICAL.

## Oiling

All bearings are self-lubricating and require no oiling.

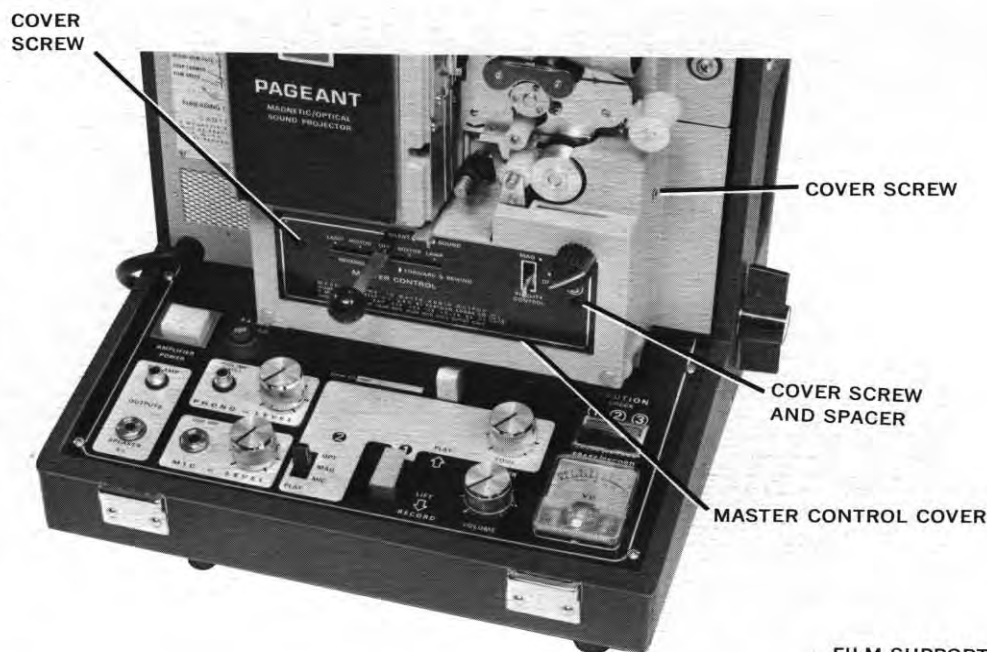
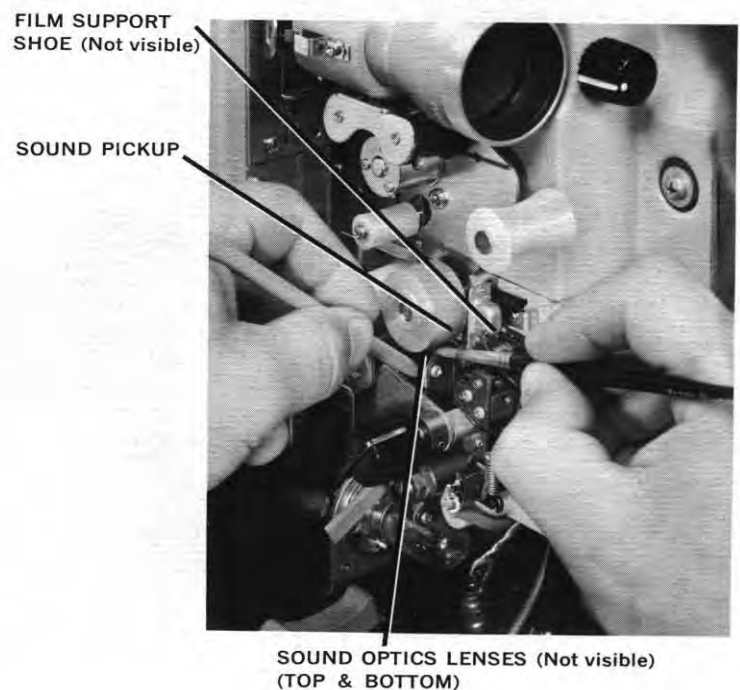

FIGURE 19



## Replacing Belts

**Rewind Belt**—Disconnect the two ends of the worn belt, connect one of these ends to an end of the new belt and pull the new belt through. If the old belt is not in position, feed the new belt into the opening in front of the supply reel arm. Guide the belt between the flanges of the pulley until the end protrudes from the opening in the top of the housing. If the end of the belt hits the housing, use a bent paper clip to guide it. The belt should go through the BELT GUARD (Figure 20).

**Take-Up Belt**—Remove the two upper sprocket-plate retaining SCREWS and the SPACER that is located behind the retaining screw nearest the front of the projector. Lift off the upper sprocket and plate assembly. Remove the old belt. Hold the new belt as shown in Figure 21, and push the looped end of the belt into the opening in the mechanism. Make sure that the STUD is inside the loop. Continue to push the belt downward until the looped end is in the GROOVE next to the sprocket drive gear. The belt should be flat in the groove. With the belt in this position, replace the upper sprocket and plate assembly, holding it firmly in a downward direction to engage the gears. Replace the retaining screws and the spacer.

**Drive Belts**—These belts, which seldom need replacing, should be installed by your serviceman.

FIGURE 20

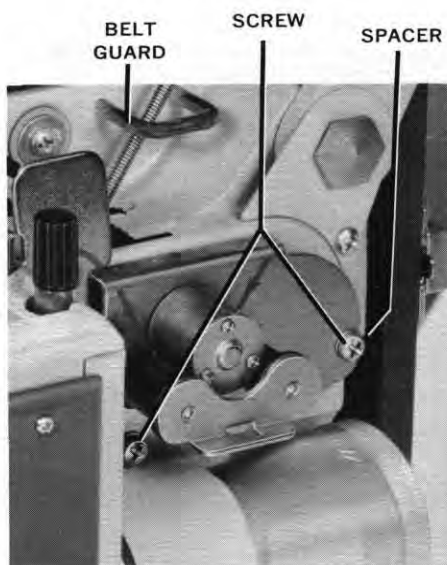

## Replacing Fuse

If the amplifier button fails to glow or the exciter lamp fails to light when the amplifier is turned on, the FUSE (Figure 22) may be blown. To remove the fuse, disconnect the power cord, turn the fuse holder counterclockwise by using a small screwdriver, and withdraw the holder. Replace the blown fuse with a new one (0.5 amp, 125V, or 250V, Slo-Blo) and replace the holder. If the amplifier button still fails to glow or the exciter lamp fails to light, the problem can be in the amplifier system. Consult a qualified serviceman to repair the amplifier.

**IMPORTANT:** Before replacing the fuse, examine the projector to determine the cause of the malfunction and then correct the condition.

FIGURE 21

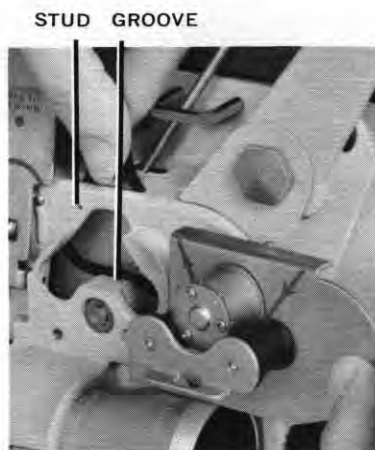

FIGURE 22



## Replacing Exciter Lamp

The EXCITER LAMP (Figure 23) in this projector operates at less than its rated voltage. It should, therefore, have extremely long life and should seldom need to be replaced.

If the lamp must be replaced, unplug the power cord; then swing the master control cover outward as described on page 17. Push the exciter lamp RELEASE LEVER down as far as it will go. Turn the lamp counterclockwise and remove it.

Place the new lamp in the socket and turn it until the large ends of the key slots in the lamp base fit over the three locating studs. The lamp will fit only one way. Turn the lamp clockwise as far as it will go. To lock the lamp in position, raise the exciter lamp release lever. Clean the lamp with a soft lintless cloth; then replace the master control cover.

FIGURE 23



## Accessories

### KODAK Projection EKTANON Lenses

Three EKTANON Lenses are available for KODAK PAGEANT Sound Projectors: 1½-inch *f*/2.0, 3-inch *f*/2.0, and 4-inch *f*/2.5. A 2-inch *f*/1.6 KODAK Projection EKTANON Lens is standard equipment with the projector. Consult the chart on page 6 to determine the relationship of screen width and projector-to-screen distance.



### CINE-KODAK Bifocal Converter (for KODAK Projection EKTANON Lens, 2-inch *f*/1.6)

Shortens the effective focal length of the projector lens to 1⅝ inches or lengthens it to 2½ inches, depending on which end of the converter is placed next to the lens. (See chart on page 6.)



## Warranty

Upon return within one year from date of purchase, a KODAK PAGEANT Sound Projector, Magnetic/Optical, Model AV-12M6, determined by Kodak to be defective in manufacture will be repaired or replaced at no charge. No other warranty, express or implied, shall be applicable to this equipment. Nor are we responsible for loss of film, for other expenses or inconveniences, or for any consequential damages occasioned by the equipment.

## Service Facilities

If your Kodak projector should require service, it may be sent to Eastman Kodak Company directly or through your dealer in Kodak audiovisual products. Complete equipment service facilities are available at the addresses listed below.

Eastman Kodak Company  
Central Equipment Service Center  
800 Lee Road  
Rochester, N. Y. 14650

Eastman Kodak Company  
Regional Equipment Service Center  
1334 York Avenue  
New York, N. Y. 10021

Eastman Kodak Company  
Regional Equipment Service Center  
5315 Peachtree Industrial Blvd.  
Chamblee, Ga. 30341

Eastman Kodak Company  
Regional Equipment Service Center  
1901 West 22nd Street  
Oak Brook, Ill. 60521

Eastman Kodak Company  
Regional Equipment Service Center  
2800 Forest Lane  
Dallas, Tex. 75234

Eastman Kodak Company  
Regional Equipment Service Center  
9100 Alcosta Blvd.  
San Ramon, Calif. 94583

Eastman Kodak Company  
Regional Equipment Service Center  
12100 Rivera Road  
Whittier, Calif. 90606

Eastman Kodak Company  
Regional Equipment Service Center  
1065 Kapiolani Blvd.  
Honolulu, Hawaii 96814

When you return equipment for repair, it should be accompanied by a description of the trouble encountered, and other available information regarding the projector, including the serial number, the date and place of purchase, and the approximate number of hours of use.

There are many Kodak publications that cover in detail a variety of subjects related to motion picture preparation and projection. These books and pamphlets offer detailed information that could not be included in this manual. For a list of such publications, write to:

Eastman Kodak Company  
Department 412-L  
Rochester, N. Y. 14650

Ask for Publications List No. MPE-1.

**KODAK, PAGEANT, SONOTRACK, SUPER-40, EKTANON, EKTANAR,  
CINE-KODAK, PRESTAPE, and LUMENIZED are trademarks.**

Motion Picture and Education Markets Division  
**EASTMAN KODAK COMPANY • ROCHESTER, N. Y. 14650**