

FILM-TECH

THE INFORMATION CONTAINED IN THIS ADOBE ACROBAT PDF FILE IS PROVIDED AT YOUR OWN RISK AND GOOD JUDGMENT.

THESE MANUALS ARE DESIGNED TO FACILITATE THE EXCHANGE OF INFORMATION RELATED TO CINEMA PROJECTION AND FILM HANDLING, WITH NO WARRANTIES NOR OBLIGATIONS FROM THE AUTHORS, FOR QUALIFIED FIELD SERVICE ENGINEERS.

IF YOU ARE NOT A QUALIFIED TECHNICIAN, PLEASE MAKE NO ADJUSTMENTS TO ANYTHING YOU MAY READ ABOUT IN THESE ADOBE MANUAL DOWNLOADS.

WWW.FILM-TECH.COM

SMART

Devices, Inc.

- Seven-channel stereo processor plus overhead channel
- Digital EX format included
- Easy interface to digital soundtrack players
- Simple operation
- 2 Rack Spaces
- UL Listed, universal voltage power supply
- A/V input for VCR, DVD, or LaserDisc

MOD 7

Seven Channel Plus Overhead Channel
Cinema Stereo Processor
With Circle Surround Analog Matrix

INSTALLATION AND OPERATION MANUAL

Copyright 2003 by SMART Devices, Inc.
5945 Peachtree Corners East
Norcross, GA 30071-1337
1-800-457-6278
or
770-449-6698

Thank you for buying this SMART product.

Please take the time to familiarize yourself with this product by carefully reading this manual. Most questions can be answered by reading and following the instructions contained herein. Because of the multitude of products from other manufacturers, this manual cannot possibly cover all the different configurations and hookups. Please consult with your Dealer, Installer, Technician or the SMART factory for any unusual situations involving the connection and use of this product with equipment from other manufacturers. When properly connected and operated, this product should deliver outstanding results.

SMART products are designed to deliver unsurpassed quality in workmanship and performance. The following information gives detailed instructions on the installation and operation of the SMART MOD 7 stereo processor. We strongly encourage new owners of the MOD 7 to thoroughly read this entire manual before placing this new product into service. This will ensure that the MOD 7 will be operated properly to give the superior performance that it was designed to deliver.

SUPPORT

For service or installation assistance, please call our Technical Support Department between the hours of 8 AM - 5 PM eastern time, Monday - Friday. Call 1-800-457-6278

You may also obtain technical support via e-mail. Please send e-mail to: service@smartdev.com

The SMART web site is <http://www.smartdev.com> You may download manuals and obtain other information about our company and its products.

LIMITED WARRANTY

SMART products and accessories are warranted against malfunction or failure due to defects in workmanship or materials for a period of one year from the date of shipment. If a problem occurs during the warranty period, the unit will be repaired, or replaced at our option, without charge for materials or labor. If air freight is requested by the dealer, the difference between air and surface charges will be billed to the dealer. This limited warranty does not cover products that have been abused, altered, modified, or operated in other than specified conditions. Prior factory approval is required on all returns. Returned equipment or defective parts must be shipped freight prepaid to us by the dealer or customer.

Our limited warranty doesn't cover damages resulting from accident, misuse or abuse, lack of responsible care, or failures not attributable to manufacturing defects, except as provided herein. SMART Devices, Inc. makes no warranties, express or implied, including warranties of merchantability or fitness for a particular purpose.

RETURN POLICY

Factory authorization MUST be obtained before returning any product. A 15% restocking charge will be issued on unused equipment (in original box) that is returned for credit. Credit is issued to the dealer's account. The credit may be used against future purchases and no cash transactions are offered. All returns must be shipped freight prepaid by the dealer. Equipment returned without a factory RA (Return Authorization) will be refused.



is a trademark of SRS Labs, Inc.

Circle Surround technology is incorporated under license from SRS Labs, Inc.

Surround EX is a trademark of Dolby Labs, San Francisco. CA

Copyright 2003 by SMART Devices, Inc.
5945 Peachtree Corners East
Norcross, GA 30071-1337

Table of Contents

SUPPORT ----- 2

LIMITED WARRANTY ----- 2

RETURN POLICY ----- 2

INTRODUCTION ----- 4

FEATURES ----- 5

 Circle Surround DSP Matrix ----- 5

 Fader Control/Remote Equalization Settings ----- 5

 Format Switching ----- 5

 Solar Cell/Reverse Scan Inputs ----- 5

 Digital Inputs ----- 5

 Music Inputs ----- 5

 Surround Channel Time Delay ----- 5

 Main Outputs ----- 5

 Main Power Supply ----- 5

 Emergency Sound Backup Power Supply ----- 5

 Monitor Output ----- 5

CONFIGURATION ----- 6

 Main Board Removal ----- 6

 Preamp Configuration ----- 6

 EX Power Up and Overhead Channel Configuration ----- 7

 Noise Reduction Configuration ----- 7

MATRIX CONFIGURATION ----- 8

 Configuration Descriptions ----- 8

 Pink Noise Setup ----- 8

 Matrix LED Indicators ----- 8

 Overhead Channel Setup (matrix) ----- 8

 Time Delay Setup ----- 9

INSTALLATION ----- 10

 Processor Placement ----- 10

 Power Supply Connections ----- 10

 Backup Power Supply ----- 10

 Soundhead Connections ----- 10

 Solar Cell ----- 10

 Reverse Scan ----- 10

 Two Projector Systems ----- 11

 Non-Sync Music Connections ----- 11

 Automation Connections ----- 11

 Muting Function ----- 11

 Digital Player Connections ----- 12

 Digital Interface DB25 Pinout ----- 12

 Default Optical Selection ----- 12

 Monitor Interface ----- 12

 Output Connections ----- 12

 Output Wiring for non-EX applications ----- 12

 Output Wiring for EX applications ----- 12

 Output Wiring for EX and Overhead Applications ----- 12

SYSTEM SETUP ----- 13

 A-CHAIN CALIBRATION ----- 13

 Preliminary ----- 13

 Soundhead Alignment ----- 13

 Slit Loss Correction ----- 14

 Optical Preamp Calibration ----- 14

 Bypass Setup ----- 15

 B-CHAIN CALIBRATION ----- 15

 Equalization and House Levels ----- 15

 Subwoofer Levels ----- 16

 Non-Sync Music Inputs ----- 16

 Time Delay ----- 16

 Digital Level Settings ----- 16

OPERATING INSTRUCTIONS ----- 18

INTRODUCTION

The MOD 7 Cinema Stereo Processor is an inexpensive, full-featured product which allows any theatre to provide the best presentation to its customers. Whether as an upgrade or in new installations, the MOD 7 offers features, ease of use, and pricing that are sure to please anyone.

The MOD 7 is the only cinema processor to incorporate the patented Circle Surround® matrix. Circle Surround produces 5 channels of audio from a standard optical stereo soundtrack. This means you can have split surround optical sound presentations in auditoriums that are equipped for split surround operation. In addition, a sub-bass channel is derived from the optical soundtrack.

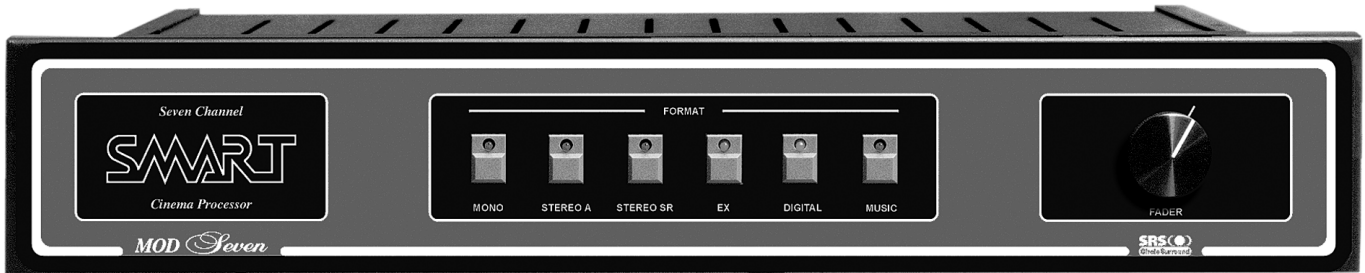

Digital soundtracks may be processed in six channel mode which includes split surrounds and subwoofer. In addition, the MOD 7 will process the surround ex channel. You do not have to add an external ex channel processor. This saves rack space and money. EX mode may be set to come on or off at power up, and it can be switched on and off easily with a front panel pushbutton.

The MOD 7 also processes the overhead channel. This is a unique feature of the MOD 7 which is not found in any other processor. Be ready when this new channel starts appearing in feature films.

The MOD 7 is fully compatible with both standard solar cell and red LED reverse scan soundheads. The preamps can be configured easily for optimum results with either type of soundhead. The Projector 2 preamp can be setup for use with a DVD, LaserDisc, or VCR player to process the audio channels into a multi-channel presentation.

To achieve the best from your new MOD 7 Cinema Stereo Processor, the theatre engineer installing the system should be totally familiar with all features and adjustments. Careful attention to detail and familiarity with the installation instructions will allow you to offer a system that has a truly exceptional sound quality.

FEATURES

Circle Surround DSP Matrix

The patented Circle Surround process produces 5 channels of audio from a standard optical stereo soundtrack. This means you can have split surround optical sound presentations in auditoriums that are equipped for split surround operation. SMART is the first manufacturer to introduce this technology into professional cinema applications. The Circle Surround Analog Matrix in the MOD 7 produces highly accurate decoding of the optical stereo A or SR soundtrack. The same matrix is used in DIGITAL format to derive the ex and overhead channels.

Fader Control/Remote Equalization Settings

The MOD 7 has one master FADER that controls the overall playback level for all eight channels. This master fader is used as the volume control for all formats. The individual left and right music level controls are located on the front right of the main circuit board (MR and ML). The octave equalization settings (7 bands plus bass and treble) are set with potentiometers on the front PCB panel, so re-equalizing the MOD VI will not be necessary in the event of a main circuit board replacement.

Format Switching

The formats on the MOD 7 are Mono, Stereo A, Stereo SR, EX On/Off, Digital and Music. All formats may be manually controlled by the gray pushbuttons on the front panel. Red Light Emitting Diodes mounted in the pushbuttons indicate the selected format. Format switching is also possible by connecting an automation or remote switch contacts to the AUTOMATION terminals on the back of the MOD 7.

Solar Cell/Reverse Scan Inputs

The MOD 7 has stereo solar cell inputs with electronic changeover for two projectors. Each pair of stereo cell inputs is an electronically balanced circuit that helps to reduce any interference pickup on the solar cell leads. Separate "neutral" leads for right and left channels allow for Reverse Scan wiring.

Digital Inputs

The MOD 7 is fully compatible with popular digital formats (i.e. DTS, Dolby Digital, etc.). The MOD 7 will easily handle the stage, split surround, and subwoofer channels from an external digital decoder.

Music Inputs

The MOD 7 processes both stereo and mono music sources from tape, CD or cartridge players. The music

is processed through the Circle Surround matrix to produce 5.1 channels of sound from a stereo music source. These inputs may be also be used as an A/V input for use with a DVD, LaserDisc, or VCR players. The music inputs are processed through the Circle Surround matrix.

Surround Channel Time Delay

The MOD 7 has a digital time delay circuit for the surround channel while playing optical stereo prints. Time delay of the surround channel in optical stereo mode is necessary for two reasons: 1) to mask any front to surround crosstalk and, 2) to synchronize the stage and surround channels to eliminate echo caused by different sound path lengths from the stage and surround speakers.

Main Outputs

The MOD 7 has seven output channels: LEFT, CENTER, RIGHT, LEFT SURROUND, CENTER SURROUND (ex or rear), RIGHT SURROUND, and SUB.

In addition, the MOD 7 includes the latest feature, an OVERHEAD channel. This channel is derived from the matrix-encoded LS and RS channels in a similar fashion as the CENTER SURROUND (ex) channel.

Main Power Supply

A fully-regulated universal voltage switching power supply is furnished with the MOD 7 processor. This supply is heavily filtered and supplies ample current for both the positive and negative 15 VDC supplies. This external power supply minimizes the chances of hum pickup when high gain electronic circuits are placed in the same chassis as a power supply.

Emergency Sound Backup Power Supply

A 120V backup power supply is included with the MOD 7 to power the backup preamp built into the MOD 7. This will reduce your chances of losing a show when using the MOD 7 processor. The 120V backup supply delivers about 12 VDC at 100mA. For installations where 120V is not available, the user should supply their own power supply. The output should be 12VDC @ 100mA and be relatively ripple free. The bypass capability is a standard feature on the MOD 7. BYPASS supplies sound to the Center Channel only.

Monitor Output

The Monitor Output db25 connector provides a convenient point for wiring a monitor to the MOD 7.

CONFIGURATION

The MOD 7 has a number of configuration options which are detailed in the following sections. Most of the configuration options are selected through the use of shunts (or jumpers) placed on header pins. Some of the options (such as those on the matrix board) are selected through the use of DIP switches. If you need to move any shunts from the default factory locations, it is probably easiest to do so before you have installed the MOD 7. The main board must be removed to get to the configuration shunts.

Main Board Removal

To remove the main board, make sure that all connections are unplugged from the back. Then, using a small blade screwdriver, gently remove the main board retainers at each end of the chassis. These retainers are just inside the front of the chassis on each end. *Carefully* unplug the ribbon cables from the front panel circuit board. The main board can now be removed by pulling it forward. It must be flexed upward slightly as it comes forward to clear the front panel board.

Reverse the procedure to re-install the main board. Be especially careful when re-plugging the ribbon cable to make sure that the connectors are properly lined up with the header pins. It is easy to mis-align these connectors.

Preamp Configuration

The MOD 7 preamps can be configured through the use of shunts placed on header pins. The drawing below shows the shunt locations and the purpose of each shunt. The PROJECTOR 2 input can be configured for use with a film projector or for use as an audio input from a video source such as a DVD, LaserDisc, or VCR. When used as an audio for video input, the left and right channels are processed through the Circle Surround matrix for multi-channel sound. The shunts for SOLAR CELL and REVERSE SCAN apply to Projector 1 and Projector 2 individually. Each projector input can be configured differently.

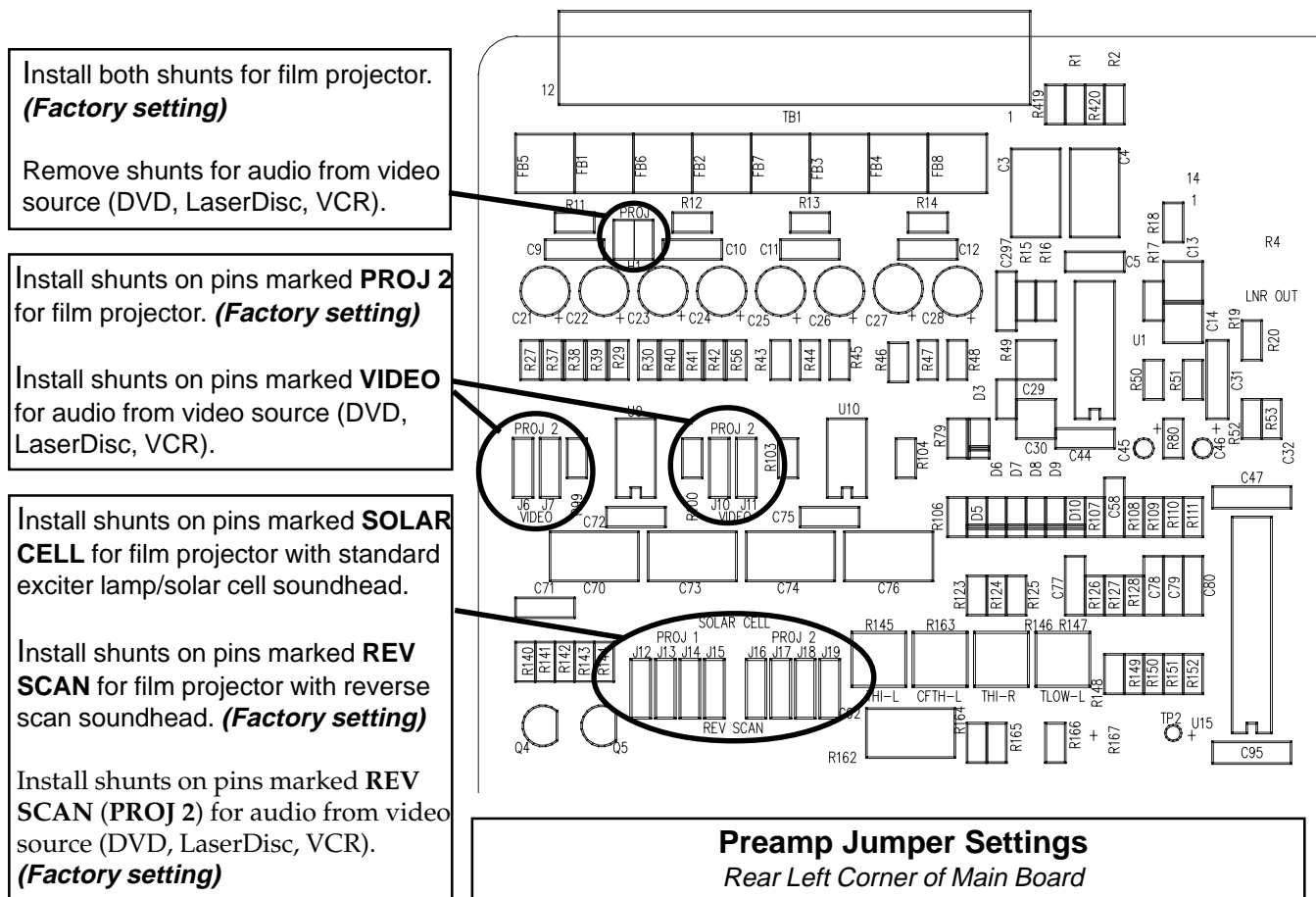

EX Power Up and Overhead Channel Configuration

The MOD 7 can be configured so that EX mode is either ON or OFF at power up. If you are not using the EX format, then place this shunt in the OFF position.

The MOD 7 can be configured to deliver an overhead channel from digital soundtracks. If you are using a digital player and have installed overhead speakers and amplifiers, then place this shunt in the OS position. Otherwise, leave it in the CS position.

This shunt determines the power-up setting for EX mode. With the shunt in the OFF position, the MOD 7 will power up with EX mode turned OFF. **(Factory setting)**

This shunt determines whether the **RIGHT REAR** output is used for a rear surround (**CS**) channel **(Factory setting)** or an overhead (**OS**) channel.

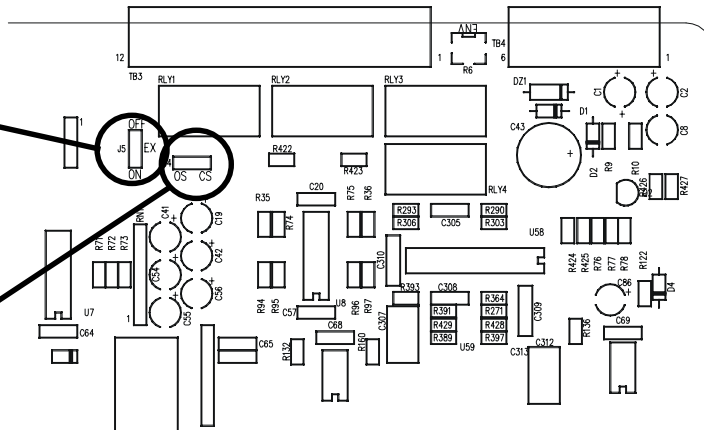

EX and Overhead Surround Jumper Settings
Right Rear Corner of Main Board

Noise Reduction Configuration

The MOD 7 can be configured to disable the Noise Reduction circuitry. This is desirable if you are using the Projector 2 input for an audio from video source (DVD, LaserDisk, VCR) since these sources are **NOT** NR encoded.

The factory setting **enables** the Noise Reduction circuitry.

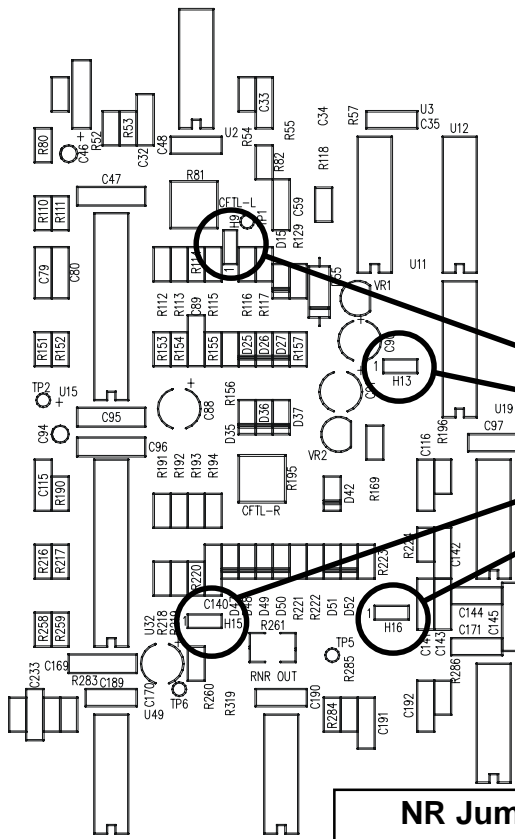

Install 4 shunts for noise reduction. **(Factory setting)**

Remove shunts for audio from video source (DVD, LaserDisc, VCR).

NR Jumper Settings
Left of Matrix Board

MATRIX CONFIGURATION

Refer to the diagram on Page 9 for locations of switches and LEDs mentioned in this section.

The DIP switches labeled CONFIGURATION are used for setting the various operating modes. Normally, all these switches are in the UP (off) position.

This configuration sets up the following modes:

Configuration Descriptions

SW1-1 causes the matrix to always be in Music mode. This mode is optimized for non-matrix-encoded material such as music CDs. Normally this mode is selected automatically so the switch should be off.

SW1-2 selects between Split or Mono Surrounds.

SW1-3 selects the Soundspread option. This allows a hard-panned left or right signal to also appear in the left surround or right surround channels. This is normally not used and is off in cinema applications.

SW1-4 selects between a phantom center channel for Left/Right/Surround systems or a real center channel for full Left/Center/Right/Surround systems.

SW1-5 OFF selects the Autobalance function which automatically corrects for minor level imbalances in the signals feeding the matrix. (SW1-5 ON defeats Autobalance.)

SW1-6 selects Front/Surround Mode or Multi-channel Mode.

SW1-7 causes the matrix to always be in Cinema mode. Useful when playing a LaserDisk or DVD through the Music inputs. (Overrides SW1-1)

SW1-8 turns on Pink Noise

Matrix LED Indicators

The STATUS LEDs indicate some of the operating conditions of the matrix. The RUN LED blinks once per second if the microcontroller is operating properly. If it is not blinking, then press the RESET pushbutton to restore proper operation.

The CS LED is on for multiple stage channel mode (either L/R or L/C/R). The FS led is on for Front/Surround operation (no left and right channels). The film LED indicates Cinema Mode and the MUSIC LED is for Music mode. In the MOD 7, the matrix will switch modes automatically as the format is changed from Music to any Film format.

The SETUP LED comes on when SW1-8 (Pink Noise Setup Switch) is on.

Overhead Channel Setup (matrix)

Place SW1-2 ON (down) when using the overhead channel. This places the surround mode of the matrix in mono which insures that all derived overhead material appears in the overhead channel.

Pink Noise Setup

Pink noise is activated by setting SW1-8 ON (down) and selecting the desired channels on SW2 as shown in the table below. **Be sure to turn OFF SW1-8 when done using pink noise.**

PINK NOISE SWITCH FUNCTIONS		
SW2	ON - PINK NOISE	OFF - NORMAL
1	Left Channel	
2	Center Channel	
3	Right Channel	
4	Left Wall Surround Channel	
5	Right Wall Surround Channel	
6	Subwoofer Channel	

CONFIGURATION SWITCH FUNCTIONS

SW1	ON	OFF
1	Force Music Mode	Auto Cinema/Music Mode
2	Mono Surrounds	Split Surrounds
3	Soundspread On	Soundspread Off
4	Phantom Center	Real Center
5	Autobalance Defeat	Autobalance On
6	Front/Surround Mode	Multi-Channel Mode
7	Force Cinema Mode	Auto Cinema/Music Mode
8	Pink Noise Setup Mode	Normal Mode

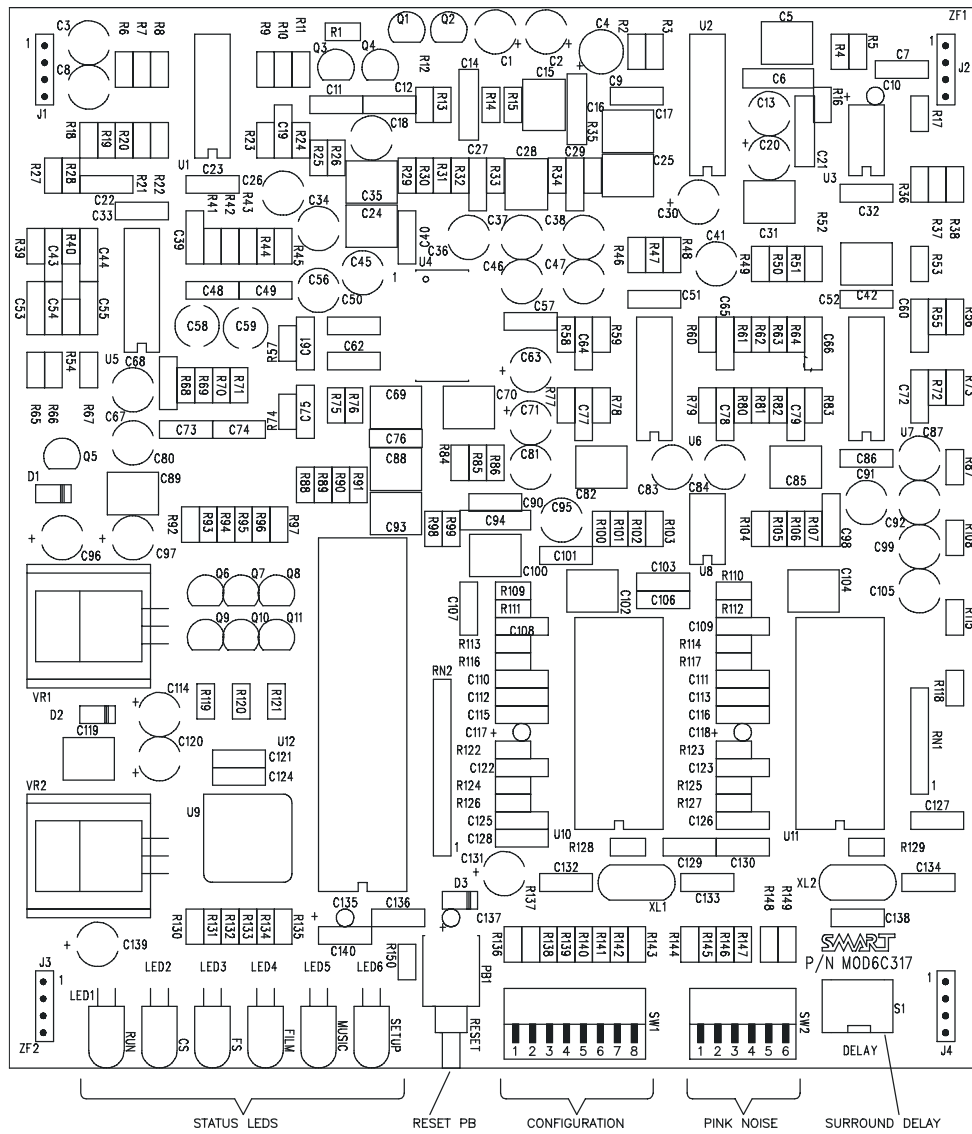

Time Delay Setup

The rotary switch is for setting the Surround Delay Time.
The switch is labeled as shown in this drawing:

POSITION	DELAY (in mSec)
0	10
1	20
2	30
3	40
4	50
5	60
6	70
7	80
8	90
9	100
A	110
B	120
C	130
D	140
E	150
F	160

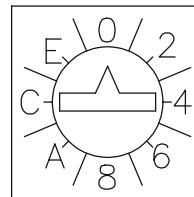

This table shows the delay for each of the switch settings. Set the time delay as you would for any stereo processor

MOD 7 STEREO PROCESSOR

INSTALLATION

Processor Placement

Before mounting the MOD 7 processor in the equipment rack or projector console, be sure to select a well ventilated area that allows cool air to circulate around the individual components. Make sure that the processor is not immediately adjacent to hum producing components such as power amplifiers with large transformers.

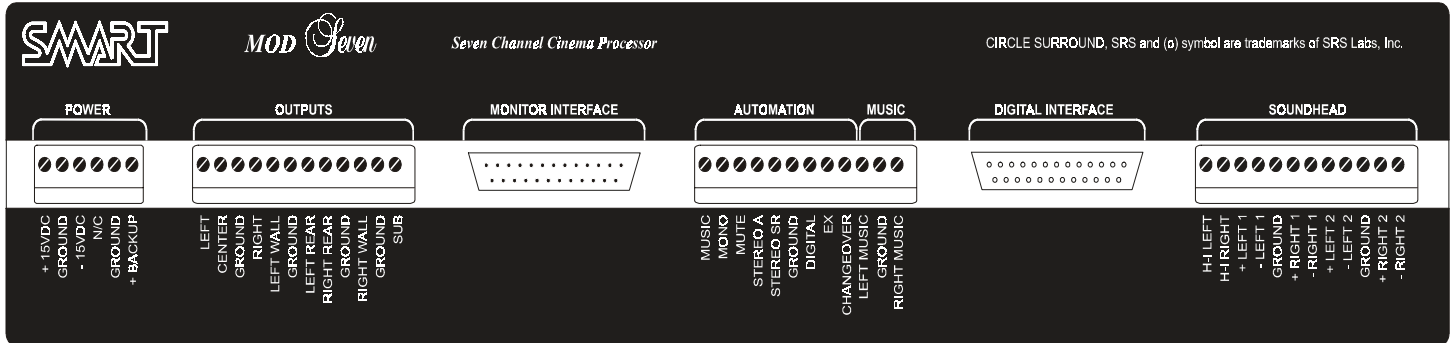

MOD 7 rear panel

Power Supply Connections

The PS-2 is a cool-running, universal switching power supply that operates on 100-250 VAC (50-60Hz), needing only a change in plug to operate in any country. It delivers clean +15 and -15 DC voltages to the MOD 7 and has enough extra power to run companion products. Mount the PS-2 in any convenient place. Run the factory supplied power supply wiring harness to the MOD VI processor. Dress the wires for appearance and craftsmanship. The wiring harness has a 6 position Phoenix pluggable terminal strip that plugs into the leftmost plug labeled POWER on the rear of the MOD 7.

WARNING: Do NOT plug a "live" power supply into the back of the MOD 7 processor! Make sure that the power supply is DISCONNECTED from the power mains before connecting to the MOD 7. Failure to heed this warning can cause fatal damage to internal components and void the manufacturer's warranty.

The wire codes for the main Power Supply are as follows (from left to right on the back of the MOD 7):

- Red : +15 VDC
- Black : GROUND
- White : -15 VDC

Backup Power Supply.

The backup power supply is a 12 VDC, 100mA supply that is furnished only for countries with 120VAC mains. It comes from the factory connected to the 6 position Phoenix connector when shipped to 120VAC mains countries. Customers in other countries will need to provide their own 12 VDC, 100mA backup supply.

The wire codes for the Backup Power Supply are as follows (from left to right on the back of the MOD 7):

- Black w/ white stripe : +BACKUP
- Black : GROUND

Remember to check all connections before applying power to the system. A wire that is reversed could be very destructive to the system.

Soundhead Connections

Solar Cell

Using three-conductor shielded cable, connect the wire from the left solar cell (red) to the corresponding +LEFT1 input terminal of the MOD 7 SOUNDHEAD connector. Connect the wire from the right solar cell (green) to the +RIGHT1 input terminal. The common solar cell lead (black) should be connected to both -LEFT1 and -RIGHT1, and the shield of the cables should be connected to a GROUND terminal. Be sure to cut off the shield at the projector end so that a ground loop is not created. Only the shields on the MOD 7 end of the cable should be grounded. It is good practice to tape or shrink wrap the end of the shielded cable at the sound head to prevent any stray shield wires from grounding out to the sound head case.

Reverse Scan

If you are using a Reverse Scan system, use a two-conductor shielded cable to connect the -LEFT1 and +LEFT1 terminals on the MOD 7 to the corresponding terminals on the Reverse Scan terminal block. Connect another two-conductor cable likewise from the -RIGHT1 and +RIGHT1 terminals to the corresponding terminals on the Reverse Scan terminal block. The "neutral" wires (-LEFT1 and -RIGHT1) should not be tied together.

If you have a second projector, repeat the above steps except hook your solar cell wires to the -RIGHT2, +RIGHT2, -LEFT2 and +LEFT2 inputs.

DOUBLE CHECK your work to see that the solar cell leads arrive at the proper terminals. A reversal of leads will cause very strange results. You may hear the center channel information through the surround speakers, the surround through the stage, and the left channel out of phase with the right. This is a common error, so verify correct wiring before proceeding.

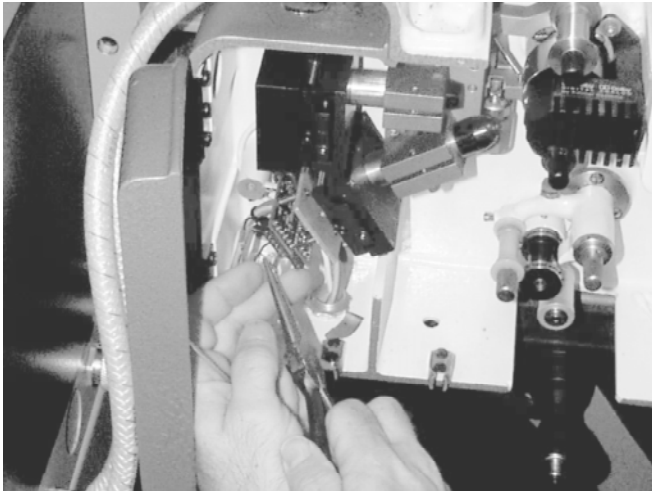

Connecting the MOD 7 to a Reverse Scan soundhead.

Two Projector Systems

Connect the **CHANGEOVER** and **GROUND** terminals on the MOD 7 **AUTOMATION** terminal strip to the booth automation changeover relay terminals.

Projector changeover is accomplished by using only a single pair of wires and either a manual switch or relay contacts in the automation system. A relay closure in the automation equipment will execute a changeover by grounding the **CHANGEOVER** terminal. Run a two-conductor shielded cable to the “dry” contacts of the automation projector changeover relay. On the other end, connect one wire to the **CHANGEOVER** terminal on the MOD 7. Ground the other wire to the nearest ground terminal on the MOD 7. Connect the shield of the wire, on the MOD 7 end, to a ground terminal. Cut off the shield on the automation end. When the automation relay closes, Projector Two of the MOD 7 will be “enabled,” and the first pair of stereo preamplifiers (Projector One) will be “disabled.” Releasing the relay will cause the reverse action to occur. In other words, Projector One is always ON until the **CHANGEOVER** terminal is grounded. The **CHANGEOVER**

terminal must be tied to ground to activate Projector Two. It is not a pulse-toggled input.

TWO PROJECTOR SYSTEMS - NO AUTOMATION:

Rig a single pole, single throw switch between the **CHANGEOVER** terminal and a **GROUND** terminal. When the switch is open, Projector 1 will be active, when it is closed, Projector 2 will be active.

NOTE : Changeover between projectors is done electronically in the MOD 7. This necessitates that BOTH exciter lamps be lit at the same time. No exciter light changeover is provided in the unit. An exciter light changeover has at least 3 dB more circuit noise than an electronic changeover and is NOT recommended in high quality systems.

Non-Sync Music Connections

The non-sync music inputs for the MOD 7 are run through the Circle Surround matrix to generate 5.1 channels of auditorium music. Connect your stereo music source (CD player, tape, etc.) to the **MUSIC LEFT** and **MUSIC RIGHT** inputs on the back of the MOD 7.

Occasionally, a theater may use a monaural sound player such as a background music cartridge player or satellite music service that does not have stereo capabilities. In this event, connecting a mono signal into both **LEFT** and **RIGHT** **MUSIC** inputs will generate music in the center channel only.

SMART recommends using a stereo distribution amplifier such as the **SMART DA226** to feed signals from one music source to multiple sound processors.

Automation Connections

Connect the format pins on the **AUTOMATION** terminal strip of the MOD 7 to the system’s corresponding automation relay terminals.

A momentary ground contact on one of the **FORMAT SELECT** inputs on the rear of the MOD 7 will switch the processor to any desired format, including music. The **EX** format select terminal will toggle between **EX ON** and **EX OFF** when pulsed to ground.

Note: The MOD 7 powers up in Non-Sync Music mode.

Muting Function

A convenient **MUTE** terminal in the **AUTOMATION** section of the back panel allows all output channels of the MOD 7 to be silenced whenever this terminal is grounded.

Digital Player Connections

The MOD 7 has six inputs (Left, Center, Right, Left Surround, Right Surround and Sub) via a female DB25 connector marked **DIGITAL INTERFACE**. The **DIGITAL INTERFACE** inputs accept any high level multi-channel source. The audio signals are processed through the equalizers and master volume circuit before they appear at the main **OUTPUTS**. If EX mode is selected, then the Circle Surround matrix processes the left surround and right surround channels to produce the rear and overhead channels.

SMART has interconnection cables available to connect the popular digital player systems to the MOD 7. Simply plug the appropriate DB25 connector to the **MOD 7 DIGITAL INTERFACE** port and the other DB25 connectors to the audio and control ports on the digital player.

If you desire to make your own cables, here is the pinout for the DB25 connector.

Digital Interface DB25 Pinout

Pin 1	Left
Pin 3	Center
Pin 5	Right
Pin 6	Left Surround
Pin 7	Right Surround
Pin 8	SubWoofers
Pin 9	Mono
Pin 10	Music
Pin 11	Stereo A
Pin 12	Digital
Pin 13	Stereo SR
Pin 14-25	Ground

Another application for the digital input is for external sync sources. Sound interlock from a 35-mm reproducer or a single 16-mm projector may be fed into the **DIGITAL INTERFACE** and selected with the front panel **DIGITAL** format switch.

Default Optical Selection

External digital decoders available on the market have a function that instructs the processor to switch to an optical format in the event that the digital decoder fails or loses time code. When this happens, the digital decoder will pulse the appropriate terminal (MONO, STEREO A, STEREO SR, or MUSIC) to ground to alert the processor to switch to the optical format. The information pertaining to which format to default to is encoded in the digital soundtracks on DTS prints. On Dolby Digital, the default is SR.

Monitor Interface

The **MONITOR INTERFACE** Port is a male DB25 connector to which a booth monitor's processor inputs can be connected. The pinout is as follows:

Pin 5	Right Rear/Overhead
Pin 7	Left Rear
Pin 12	+15 VDC
Pin 13	-15 VDC
Pin 15	Subwoofer
Pin 17	Right Wall
Pin 19	Left Wall
Pin 21	Right
Pin 23	Center
Pin 25	Left
Pins 2, 4, 6, 8, 10, 16, 18, 20, 22, & 24	Ground

Output Connections

The main **OUTPUTS** are labeled **LEFT**, **CENTER**, **RIGHT**, **LEFT WALL**, **LEFT REAR**, **RIGHT REAR**, **RIGHT WALL**, and **SUB**. Shielded cable should be run between these terminals and the next piece of equipment in the sound system (equalizer, amplifier, etc.). Convenient **GROUND** terminals are provided near the outputs.

Output Wiring for non-EX applications

If you are not using the EX feature, then wire all surround amplifiers to the **LEFT WALL** and **RIGHT WALL** terminals. Do not use the **LEFT REAR** and **RIGHT REAR** terminals.

Output Wiring for EX applications

If you are using the EX feature, then wire the left wall and right wall amplifiers to the **LEFT WALL** and **RIGHT WALL** terminals. Wire the left rear and right rear amplifiers to the **LEFT REAR** and **RIGHT REAR** terminals. Please note: the CS/OS shunt must be in the **CS** position (see top of Page 7 titled **EX Power Up and Overhead Channel Configuration**)

Output Wiring for EX and Overhead Applications

If you are using the EX and overhead features, then wire the left wall and right wall amplifiers to the **LEFT WALL** and **RIGHT WALL** terminals. Wire the left rear and right rear amplifiers to the **LEFT REAR** terminal. Wire the overhead amplifier to the **RIGHT REAR** terminal. Please note: the CS/OS shunt must be in the **OS** position (see top of Page 7 titled **EX Power Up and Overhead Channel Configuration**) Also SW1-2 on the matrix must be set to the **DOWN** position.

SYSTEM SETUP

Required Equipment

- sound pressure level meter
- real time analyzer (RTA) with a calibrated microphone
- dual trace oscilloscope
- multimeter
- a tuning wand
- S.M.P.T.E. Buzz Track Loop
- C.A.T. #97 Stereo Cell Alignment Film
- C.A.T. #69 Test Film

Before Calibrating

Turn on sound systems for 1/2 hour.
 Turn off the EX feature.
 Close the auditorium doors.

A-CHAIN CALIBRATION

The A chain is usually considered to be the signal path originating from the solar cell and continuing to the processor's master fader. This signal path includes the preamp, noise reduction and matrix stages.

Preliminary

Clean soundhead optics, exciter lamp, optical lens and solar cell before attempting a soundhead alignment.

Set exciter lamp voltage for at least 80% of rated voltage.

- BMX 9 volt 4 amp – 7.2 volts
- BXN 10 volt 5 amp – 8 volts
- Most foreign 6.3 volt 4 amp – 5 volts

Make sure film/cell spacing is approximately 1 mm with the slit image striking the top one-third of the solar cell.

Open the MOD VI front panel and connect Oscilloscope and real time analyzer to the TP7 (left preamp) and TP8 (right preamp) test points.

TP7 and TP8 are located on the bottom side of the front center of the MOD 7 main board between the J1 and J2 connectors. TPG (GROUND) is located to the left of J1, also on the bottom side.

Turn Gain controls fully clockwise.

Turn Slit Loss controls fully counterclockwise.

The Preamp Gain controls are R1 and L1 for projector 1, and R2 and L2 for projector 2. The Slit Loss controls are LHF1 and RHF1 for projector 1, and LHF2 and RHF2 for projector 2. Both sets of trimpots are located on the left hand side of the front of the main circuit board.

Turn the master FADER all the way down to avoid excessive noises in the auditorium for the next steps.

Soundhead Alignment

- 1 **Play a S.M.P.T.E. Buzz Track loop.**
 - 2 Adjust the lateral film guide assembly, laser lens assembly or exciter lamp assembly while monitoring the preamp signals with the oscilloscope.
 - 3 Adjust for minimum signal on the left and right channels.
- Refer to specific instructions in the projector soundhead manual. Minor variations in alignment procedure depend on the individual mechanical design of the soundhead.
- 4 **Play C.A.T. # 97 Stereo Cell Alignment Film.**
 - 5 Move laser lens or solar cell laterally and vertically until you have achieved minimum crosstalk between channels (see figure 6).
 - 6 Repeat steps 1-5 until no further improvement can be obtained.

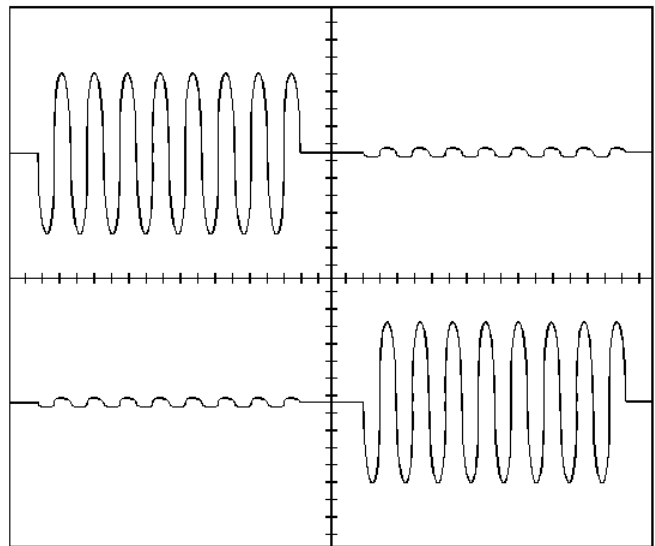

Figure 6. Low crosstalk between channels

- 7 **Play Pink Noise side of C.A.T. #69 Test Film.**
- 8 Switch oscilloscope to X/Y Mode.
- 9 Adjust sound head optical lens azimuth for narrowest diagonal trace (see figure 7).

10 Observe the real time analyzer and focus the lens for maximum high frequency output while maintaining the best azimuth.

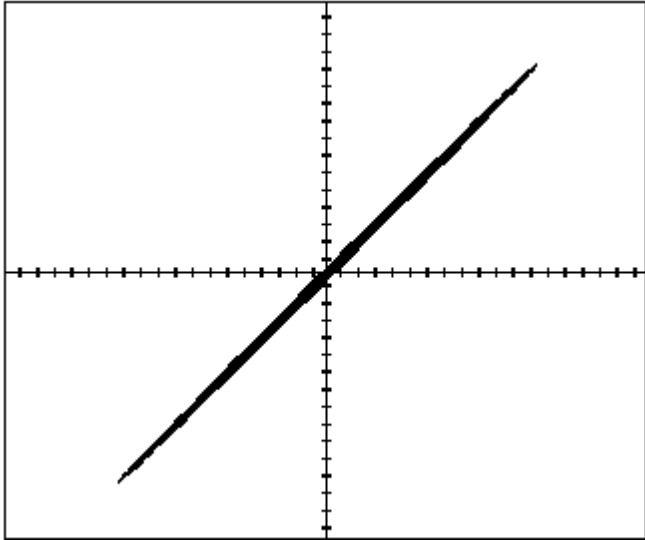

Figure 7. Pink noise in X/Y mode on the oscilloscope.

This is not easy, but it is one of the most critical adjustments affecting the overall system performance and is often not done as well as it should be.

11. Adjust the vertical and lateral alignment of the EXCITER LAMP for maximum output on both channels. This is especially critical with a narrow slit optical lens because there is a much smaller "window" for the light to pass through.

12. Check the high frequency output on both channels and make sure the response is the same on both channels.

With a narrow slit optical lens, the response should be flat within ± 3 dB to about 12 kHz with NO slit loss correction. If not, this MUST be corrected before proceeding with the next steps. It is not permissible to use slit loss correction to correct poor high frequency response caused by misalignment of the optical soundhead. An EXCITER LAMP out of alignment, the barrel of the optical lens crooked, or oil in the optical lens will all affect output and balance.

Slit Loss Correction

1. Run the Pink Noise side of C.A.T. #69 Test Film.

2. Observe the frequency response on your RTA which should be still connected to the preamp testpoints.

2. Adjust the left and right slit loss correction trimpots on the PREAMP for optimum flat high frequency response.

Do not over adjust the slit loss correction in an effort to obtain extended response. This will result in an undesirable frequency response peak. While adjusting the slit loss correction, aim for as flat a high frequency response as possible. If one of the preamp channels is slightly worse than the other, then adjust the better responding preamp to match the lesser. This will ensure that the matrix steering in the MOD 7 will be as accurate as possible.

Optical Preamp Calibration

1. Run a Dolby C.A.T. #69 Test Film, Dolby tone side.

2. Locate the preamp calibration switch (SW1) and LEDs (LED1 and LED2) on the left hand side of the front of the main circuit board.

3. Push SW1 to the left. This causes the LEDs to indicate the status of the Left channel preamp level.

Make sure you are changed over to the correct projector by observing the **CHANGEOVER** terminal on the back of the MOD 7. If the pin is open, the system is in projector 1 mode, if it is grounded, the system is in projector 2 mode.

4. Adjust Projector 1 left channel gain control (L1) until both LEDs are lit.

This is a critical adjustment. You may not be able to get both LED's on simultaneously. Try to get as close as possible.

5. Repeat steps 1-4 for the right channel gain control (R1), and for projector 2 left and right channel gain control (L2 and R2).

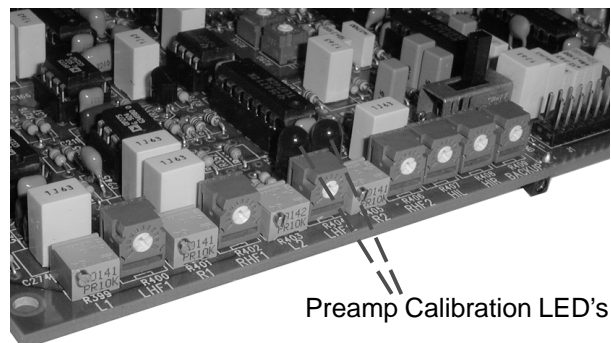

Left side potentiometers (Preamp, slit loss, hearing impaired, and backup levels) and preamp calibration selector switch (SW1).

You can verify that the LED meters are indicating correctly by connecting an AC voltmeter to the LEFT PRE (TP7) and RIGHT PRE (TP8) test points located on the bottom side of the front of the main circuit board between connectors J1 and J2. Ground (TPG1) is located to the left of J1. You should read between 300 to 325mVAC at these test points.

Bypass Setup

Bypass mode generates mono sound in the Center channel. It is activated by pressing the red rocker switch to the BYPASS position.

1. Run a film soundtrack.
2. Listen to the CENTER channel on the booth monitor.
3. Switch from Normal to Backup.

The red Backup Switch (SW2) is mounted on the front right of the main board, behind the front panel. Pushing the switch to the right is BYPASS mode, to the left is NORMAL mode.

4. Adjust the BYPASS level pot (on the left front side of the main board) to achieve equal levels while switching from Normal mode to Bypass mode.

B-CHAIN CALIBRATION

The B Chain Calibration is generally considered to be the signal path from the processor's master fader to the speakers. This signal path includes the equalizers and output stage. Before continuing with the B Chain Calibration, check the wiring of all auditorium speakers to make sure the phase is correct.

Preliminary

Special Note: If you will be installing an external digital decoder, do so AFTER setting house levels. See the DIGITAL LEVEL SETTINGS at the end of the B CHAIN CALIBRATION section for more information.

1. Select STEREO A by pushing the appropriate button on the front panel.
2. Set the FADER to the one o'clock position.

Equalization and House Levels

The equalizers are normally shipped with the individual trimpots set for a flat frequency response. The octave equalizers used for the stage channels are capable of

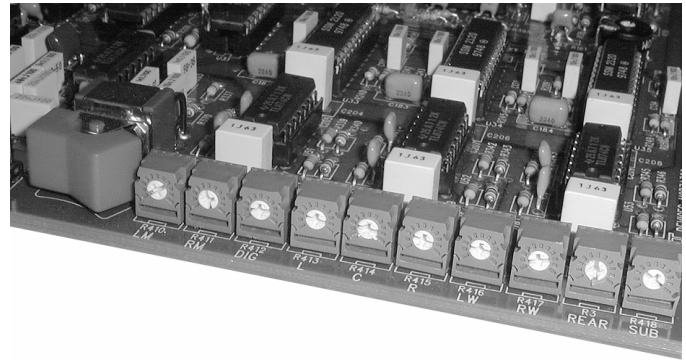

Right side trimpots (Music, Digital, and Main output levels) and Emergency Bypass switch

cutting and boosting each frequency ± 10 dB. The individual trimpots are single turn types, with the mid position of each pot being flat (unity gain).

The MOD 7 has a built in Pink Noise Generator on the Circle Surround Matrix Board. See pages 8 and 9 for a description of the pink noise and time delay switches

Set the pink noise channel switches (SW2) on the Circle Surround Matrix Card to the correct setting for the channel you wish to equalize. Select the **STEREO SR** format.

Perform the channel equalization using the trimpots located inside the front panel. The **LO** trimpot in each EQ section mainly affects frequencies below 100Hz, and the **HI** trimpot mainly affects frequencies above 10kHz.

After equalization of the each stage channel, adjust its output level using the **L**, **C**, and **R** output trimpots on the right front of the main circuit board so that 79 dBc spl is measured in the auditorium for each channel.

If you are **NOT** using the **EX** feature, follow this procedure for the Left Wall Surround and Right Wall Surround channels. Adjust equalization as you normally would. Then set the **LW** and **RW** level trimpots to obtain 76 dBc spl in the auditorium for each channel.

If you **ARE** using the **EX** feature, follow this procedure for the Left Wall Surround, Right Wall Surround, and **EX** channels. Turn **OFF** the rear channel amplifier (or disconnect the rear speakers from the rear amplifier). Adjust equalization as you normally would. Then set the **LW** and **RW** level trimpots to obtain 76 dBc spl in the auditorium for each channel.

MOD 7 STEREO PROCESSOR

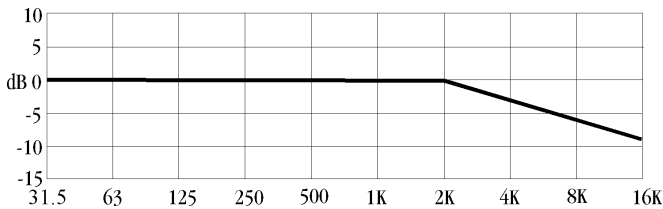

ISO Cinema Playback Standard states that octave bands should be tuned for flat response to 2 kHz, with a 3 dB/octave rolloff above 2 kHz.

Now turn **ON** the rear channel amplifier and turn **OFF** the left wall and right wall amplifier. Select left wall surround AND right wall surround pink noise by pushing down switches 4 and 5 on the pink noise dip switches. Equalize the rear channel. Then adjust the **REAR** output level trimpot for 76 dBc spl in the auditorium. Restore all amplifiers to the **ON** condition.

If you are using the **OVERHEAD** feature, select **DIGITAL** format. Also select **EX** format. Select left wall surround pink noise only. Adjust the **ENV** level trimpot (located on the MOD 7 rear panel by the power connector-see picture on page 17) to obtain 76 dBc spl in the auditorium.

Subwoofer Levels

With the SubWoofer Pink Noise channel on, adjust the sub level trimpot (SUB) to the right on the front of the main circuit board for 79 dBc spl from the subwoofer. The installer may wish to adjust for another level, depending on the amount of subwoofer desired.

Non-Sync Music Inputs

Select Music mode and turn on the music source that is feeding the MOD 7.

Turn the left and right music level trimpots (LM and RM) on the right front of the main board to obtain a normal house level.

These trimpots are factory set and may not need adjustment. Adjust the trimpots so that right and left music are set to the same level. A way to accomplish this is to play a stereo music selection with a good vocal track and adjust either the left or right music trimpots for minimum vocals in the surround channel.

The music is played through the matrix the same as a soundtrack and provides 6 channel decoding from a conventional 2-channel stereo source. This feature in the MOD 7 presents a high impact playback in the auditorium for pre-show entertainment. Although all 2 channel commercial stereo recordings contain hidden "extra channel" information due to multiple microphone recording or multi-track mixdown, you will really appreciate the effect if you purchase CD's that have been encoded in "Circle Surround" with 6-channel source. There are many new recordings available with the "Circle Surround" logo on the CD case.

Time Delay

Measure the distance in feet from the ideal seat (which is usually 2/3 of the way back from the stage speakers, centered side to side) to the stage speakers.

Measure the distance from the ideal seat to the nearest surround speaker.

Subtract the two measurements.

Add 20 to this number to get the delay (in milliseconds) required in the auditorium.

Set the rotary switch on the Circle Surround Matrix Card (S1) to the nearest setting in milliseconds. See Page 9 for a description of the time delay settings.

Digital Level Settings

The MOD 7 offers a digital level modifier trimpot (DIG) that provides cut from the main FADER level when in digital mode. In addition to externally trimming the DIGITAL INPUT signals, the installer may use this trimpot to fine tune the DIGITAL to Stereo-Optical sound level matching.

Make sure that all other B-chain calibration adjustments have been made prior to adjusting the digital levels (see special note in the PRELIMINARY section of the B CHAIN CALIBRATION).

Make adjustments at the output of the external digital decoder or interlock audio tape machine (see the digital player manufacturer's manual for details).

Use the DIG trimpot (located on the front right side of the main circuit board) to fine-tune the digital level relative to the Stereo-Optical level.

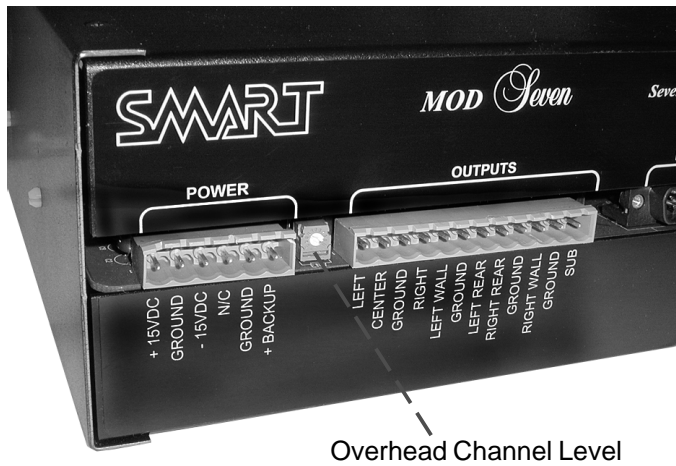
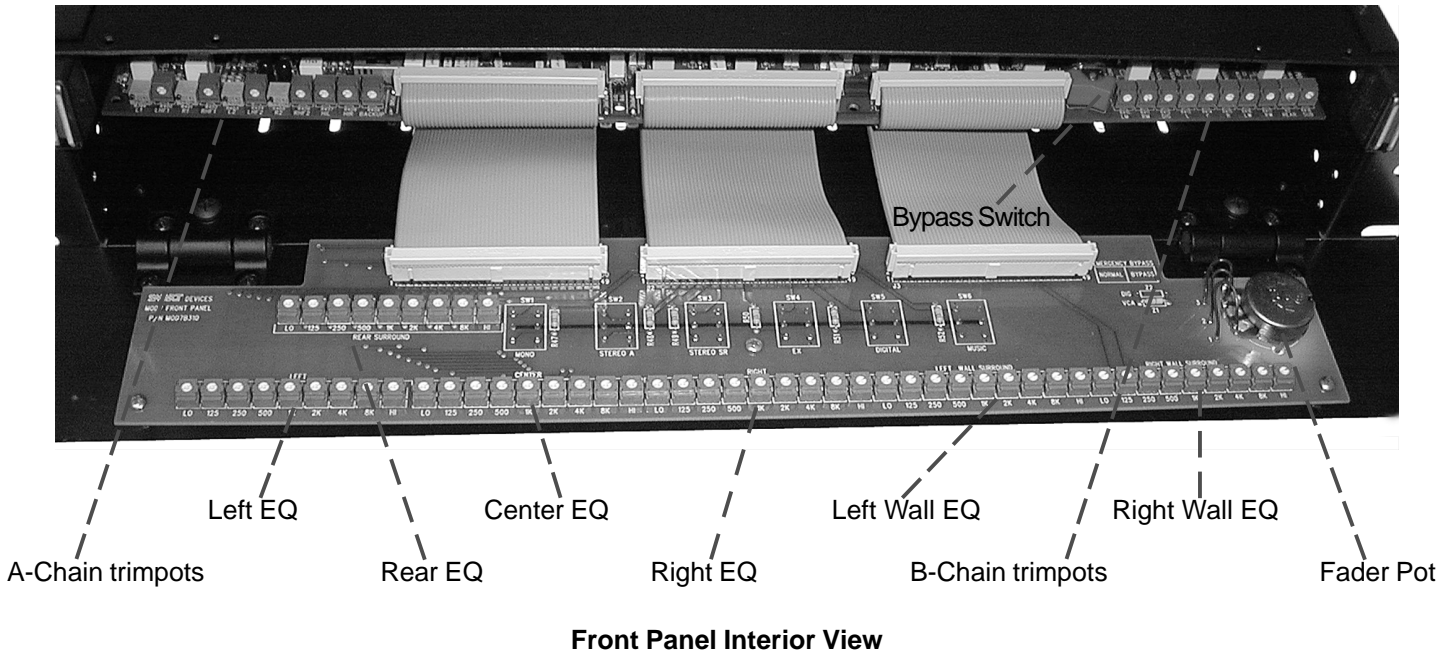

The Overhead Level trimpot is located on the back panel by the power connector. This will only need adjustment if you are employing overhead speakers and amplifier.

The Hearing Impaired level and Backup Level adjustments are located in the A-Chain trim pots section on the left hand end of the main board. The Preamp Calibration selector switch is located just behind the Backup Level trimpot. When the slide switch is to the left, the Left Channel preamp is selected. When moved to the right, it selects the Right Channel preamp.

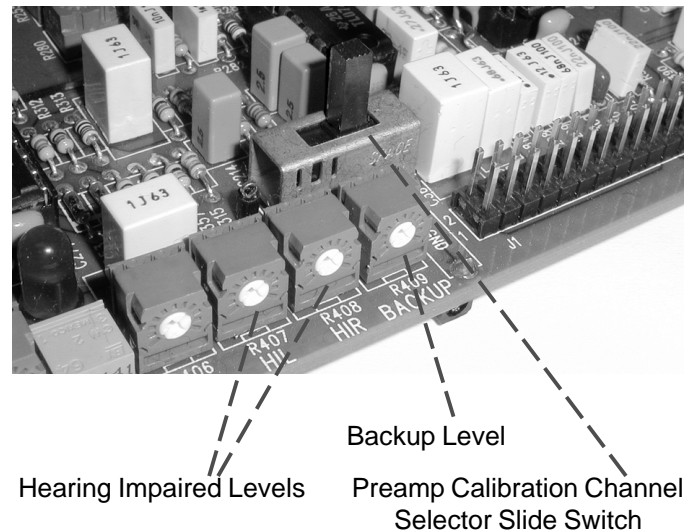

OPERATING INSTRUCTIONS

The MOD 7 system is one of the easiest systems to operate. The Manager/Operator of the sound booth should review the operation instructions to assure that emergency functions are also understood in the unlikely event of an equipment failure.

TURNING ON THE SYSTEM

The sound engineer who installed the sound system has provided a way to apply power to the system through a master power switch or circuit breaker. Also, several of the individual components in the equipment rack have their own power switches. Become familiar with all switches or breakers that control power to the sound equipment.

The MOD 7 is equipped with a power up muting circuit that allows time for the low level circuits to stabilize before enabling the processor outputs. This circuit prevents a "turn-on thump" from being passed to the auditorium speakers. However, since most amplifiers are not equipped with a comparable muting circuit for the power down sequence, it is recommended that the amplifiers be turned off before the processor to avoid a "turn-off thump" in the auditorium.

MUSIC SELECTION

It is likely that the sound system will be turned on before the arrival of the first audience of the day. The MOD 7 powers up in Music mode. If the music player (CD player or tape machine) is running, music will be heard in the auditorium and on the booth monitor. Music may also be selected by pressing the front panel MUSIC button.

PROGRAM SELECTION

The automation should be set to select the proper formats when needed. However, any format may be overridden by simply pushing one of the Format buttons located on the front of the MOD 7.

VOLUME LEVEL

The front panel **FADER** control is used to set the system level for any format. The system was calibrated with the **FADER** at the one o'clock position, which is where most prints will play at a normal level.

MUSIC LEVEL CONTROL

The music level should have been preset by the installer of the sound system. However, if any change in music level is desired then the LM (Left) and RM (Right) music level controls can be turned to change the overall volume level. These trimpots are located behind the front panel on the right front of the main circuit board. The front panel is mounted on hinges and latched by magnets, so a light tug on the top of the panel should open it for access.

BYPASS SWITCH

The MOD 7 contains an emergency bypass system that will keep the sound on the screen in the event of a failure of the processor. This special circuitry is activated by the **BYPASS** switch, which is located behind the front panel on the front right of the main circuit board. The switch is bright red, and switching it to the right puts the system in **BYPASS**, to the left is **NORMAL** mode. During **BYPASS**, sound is produced only through the Center channel.

BYPASS uses the same preamp circuitry as normal operation. The power is supplied simultaneously by the main supply and a small backup power pack. In the unlikely event of preamp circuitry failure, the backup system may not function. If this happens, please contact your service technician or call the SMART factory.

EX Format

The **EX** function (activated by the button on the front panel) applies special processing to the Left Surround and Right Surround channels in **DIGITAL** format. This process extracts the Center Surround (REAR) channel. If your system is equipped for EX playback, SMART recommends keeping EX turned on all the time.

If your cinema is NOT equipped to play in EX format, then make sure to keep the EX format turned off.