

Film-Tech

The information contained in this Adobe Acrobat pdf file is provided at your own risk and good judgment.

These manuals are designed to facilitate the exchange of information related to cinema projection and film handling, with no warranties nor obligations from the authors, for qualified field service engineers.

If you are not a qualified technician, please make no adjustments to anything you may read about in these Adobe manual downloads.

www.film-tech.com

SIMPLEX

Type C-60 TUBE Sound System

PARTS LIST

Edward H. Wolk, Inc.
921 South Jefferson St.
Chicago, ILL. 60607-4422
Phone: (312) 939-2720
1-800-621-4424
Fax: (312) 939-0654
Website: www.edwolk.com

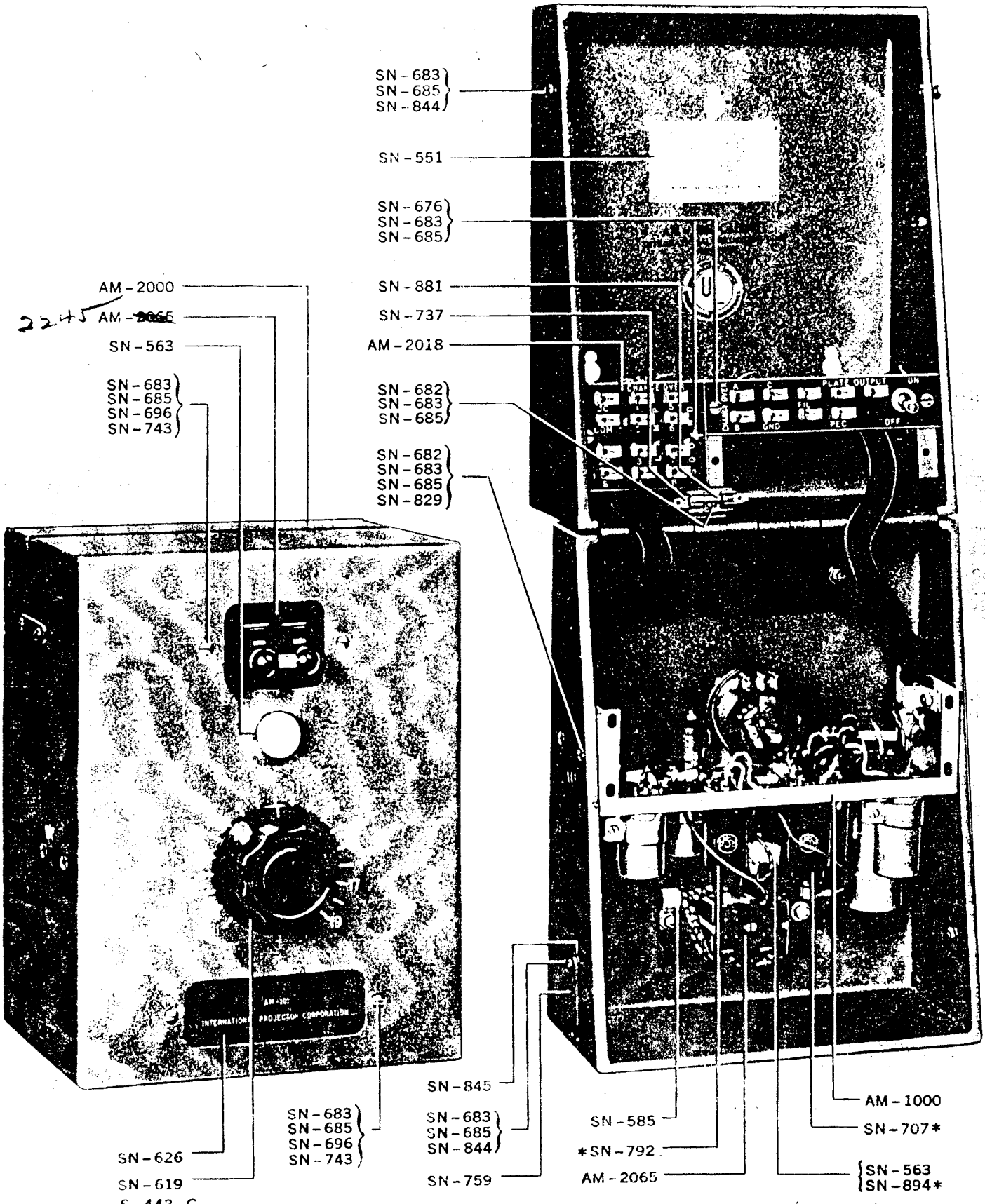

AM-101 VOLUME CONTROL AMPLIFIER

*INDICATES NON-COMPONENT ITEM
MUST BE ORDERED SEPARATELY

**NOTE: Knobs are manufactured by:
HARRY DAVIES MOLDING COMPANY
4920 West Bloomingdale Ave.
Chicago, ILL. 60639
Phone: (312) 622-8966

AM-101 VOLUME CONTROL AMPLIFIER

AM-1000	Volume Control Amplifier
AM-2000	Cabinet
AM-2018	Terminal Strip Assembly
AM-2065	Changeover Switch
SN-551	License Plate
SN-563	Socket, Pilot Lamp
SN-585	Cable Clamp
** SN-619	Knob (Set Screw, S-442-G) Davies # 4109 (3")
SN-626	Name Plate
SN-676	Screw (8-32 x 3/8) (4)
SN-682	Screw (8-32 x 1/2) (5)
SN-683	Nut (8-32) (17)
SN-685	Lockwasher (17)
SN-696	Washer (4)
*SN-707	Vacuum Tube Type 6J7
SN-737	Mounting, Fuse
SN-743	Screw (8-32 x 3/8) (4)
SN-759	Link (2)
*SN-792	Vacuum Tube Type 6J7 (B-31 Stock)
SN-829	Lug, Ground
SN-844	Screw, Special (4)
SN-845	Washer (2)
SN-881	Fuse
*SN-894	Lamp, Pilot

* Indicates Non-Component Item
Must be ordered separately

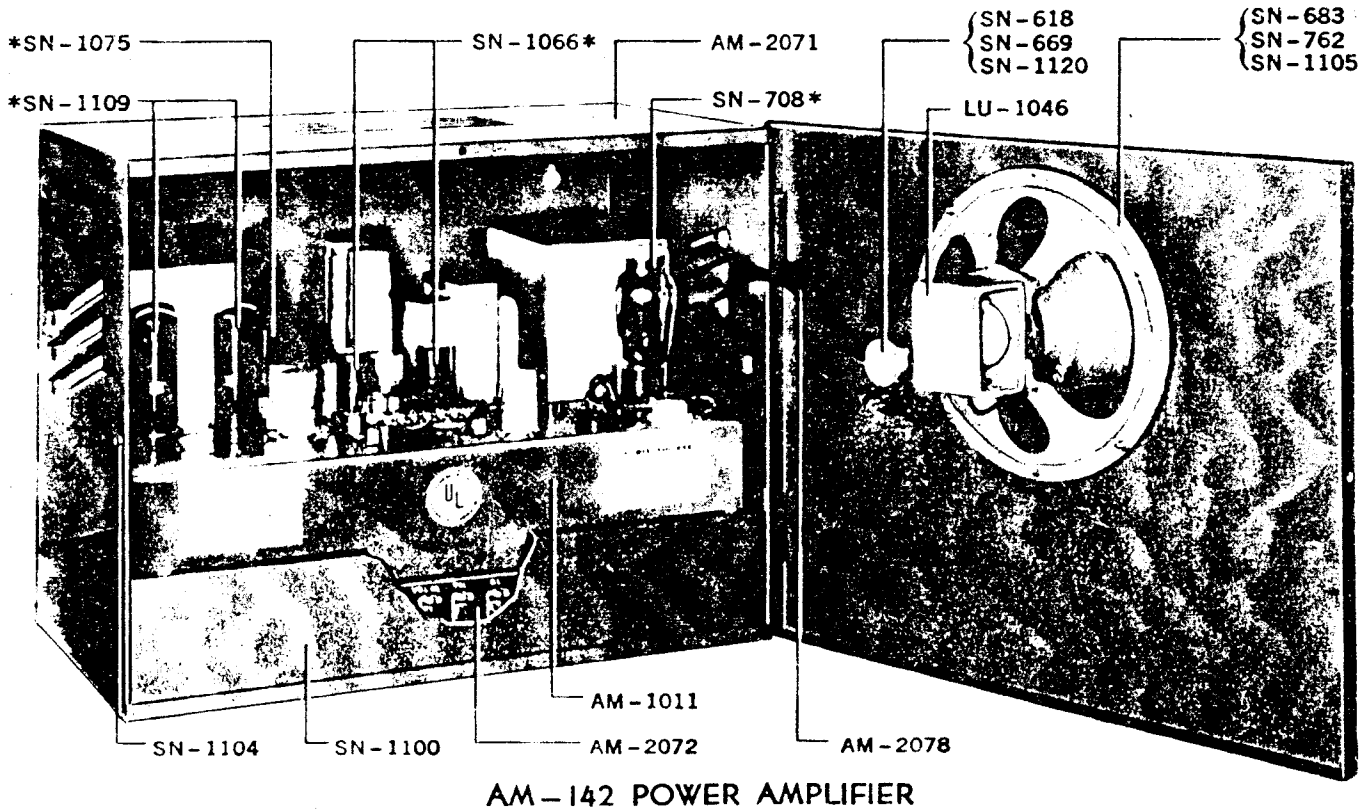
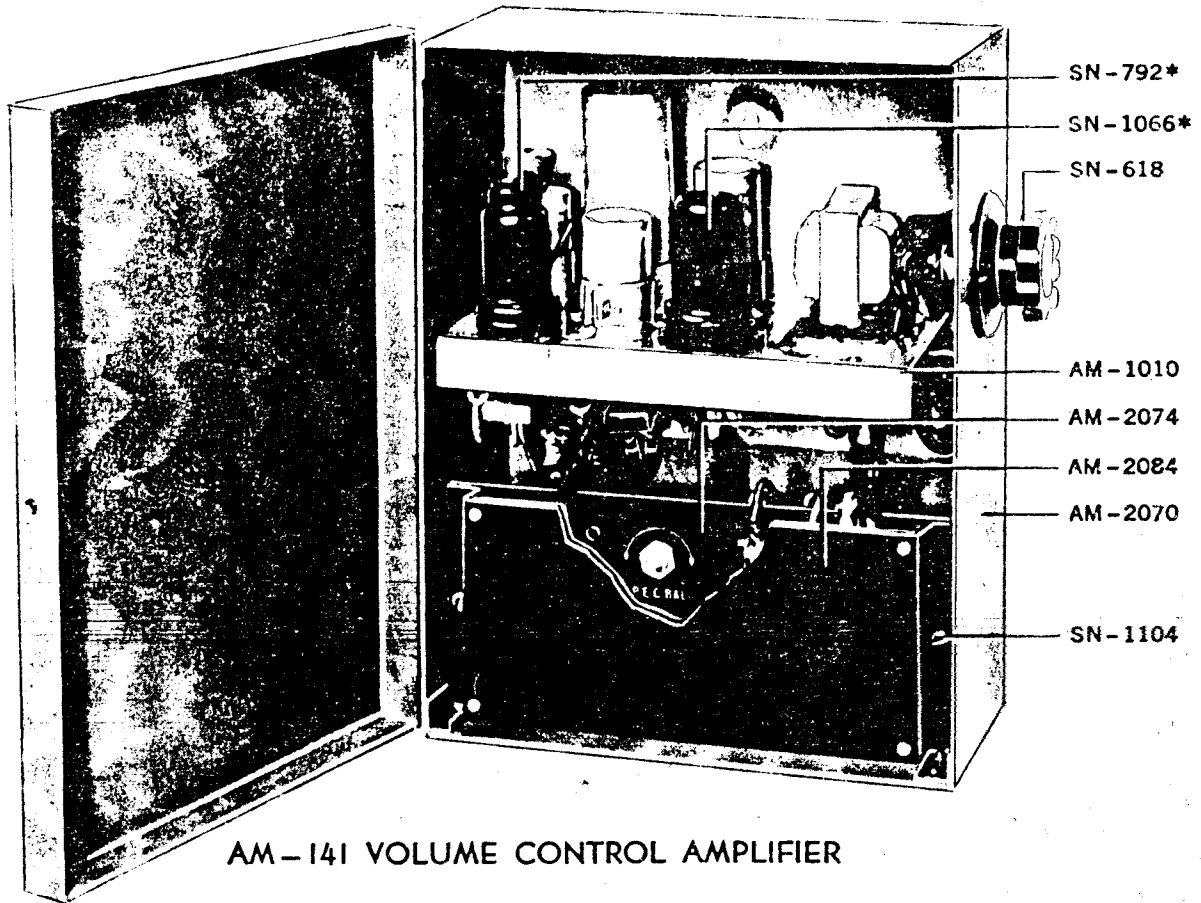

* INDICATES NON-COMPONENT ITEM
MUST BE ORDERED SEPARATELY

AM-141 VOLUME CONTROL AMPLIFIER

AM-1010	Volume Control Amplifier
AM-2070	Cabinet
AM-2074	Terminal Strip Assembly
AM-2084	Shield
SN-618	Knob
*SN-792	Vacuum Tube Type 6J7 (B-31 Stock)
*SN-1066	Vacuum Tube Type 6SJ7
SN-1103	Screw (8 x 1/4 long) (2)
SN-1104	Screw (8 x 1/2 long) (3)

AM-142 POWER AMPLIFIER

AM-1011	Power Amplifier
AM-2071	Cabinet
AM-2072	Terminal Strip Assembly
AM-2078	Cable and Plug Assembly
LU-1046	Monitor Unit
SN-618	Knob
SN-669	Nut (3/8-32) (2)
SN-683	Nut (8-32) (4)
*SN-708	Vacuum Tube Type 5Z3
SN-762	Washer, Cup (4)
*SN-1066	Vacuum Tube Type 6SJ7 (2)
*SN-1075	Vacuum Tube Type 6F6
SN-1100	Panel
SN-1104	Screw (8 x 1/2 long) (3)
SN-1105	Screw (8-32 x 3/4) (4)
*SN-1109	Vacuum Tube Type 6L6 (2)
SN-1120	Potentiometer

* Indicates Non-Component Item
Must be ordered separately

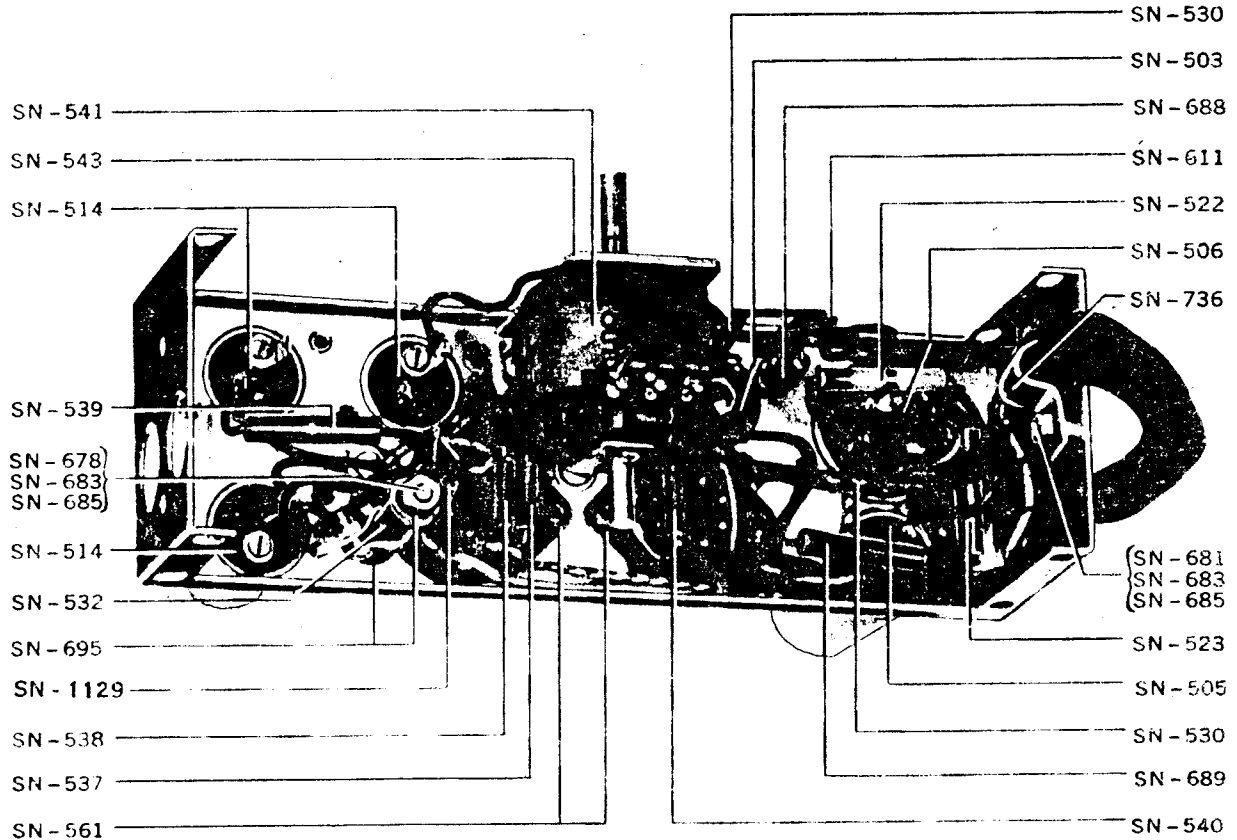
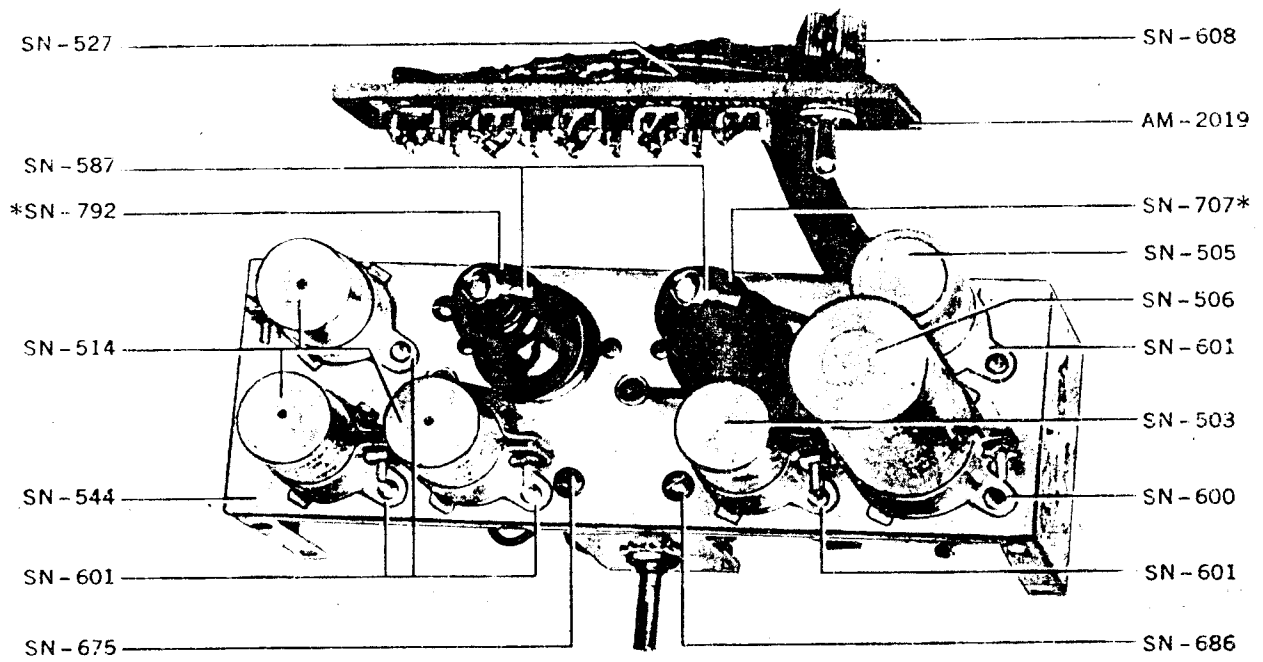

AM-1000 VOLUME CONTROL AMPLIFIER

*INDICATES NON-COMPONENT ITEM
MUST BE ORDERED SEPARATELY

AM-1000 VOLUME CONTROL AMPLIFIER

AM-2019	Terminal Strip Assembly
SN-503	Capacitor 10 Mfd 50 V
SN-505	Capacitor 10 Mfd 50 V with paper sleeve
SN-506	Capacitor 8 @ 150V, 8 @ 250V, 10 @ 50V
SN-514	Capacitor (3) .05 mfd 400 V
SN-522	Resistor
SN-523	Resistor
SN-527	Resistor
SN-530	Resistor (2)
SN-532	Resistor
SN-537	Resistor
SN-538	Resistor
SN-539	Resistor
SN-540	Resistor
SN-541	Potentiometer
SN-543	Bracket
SN-544	Chassis
SN-561	Socket, Octal (2)
SN-587	Grid Cap (2)
SN-600	Clamping Ring
SN-601	Clamping Ring (5)
SN-608	Switch, D.P.S.T.
SN-611	Terminal Strip
SN-675	Screw (8-32 x 1/4) (2)
SN-678	Screw (8-32 x 2-1/4)
SN-681	Screw (8-32 x 3/8)
SN-683	Nut (8-32) (2)
SN-685	Lockwasher (2)
SN-686	Lockwasher (2)
SN-688	Resistor
SN-689	Resistor
SN-695	Washer (2)
*SN-707	Vacuum Tube Type 6J7
SN-736	Cable Clamp
*SN-792	Vacuum Tube Type 6J7 (B-31 Stock)
SN-1129	Resistor

* Indicates Non-Component Item
Must be ordered separately

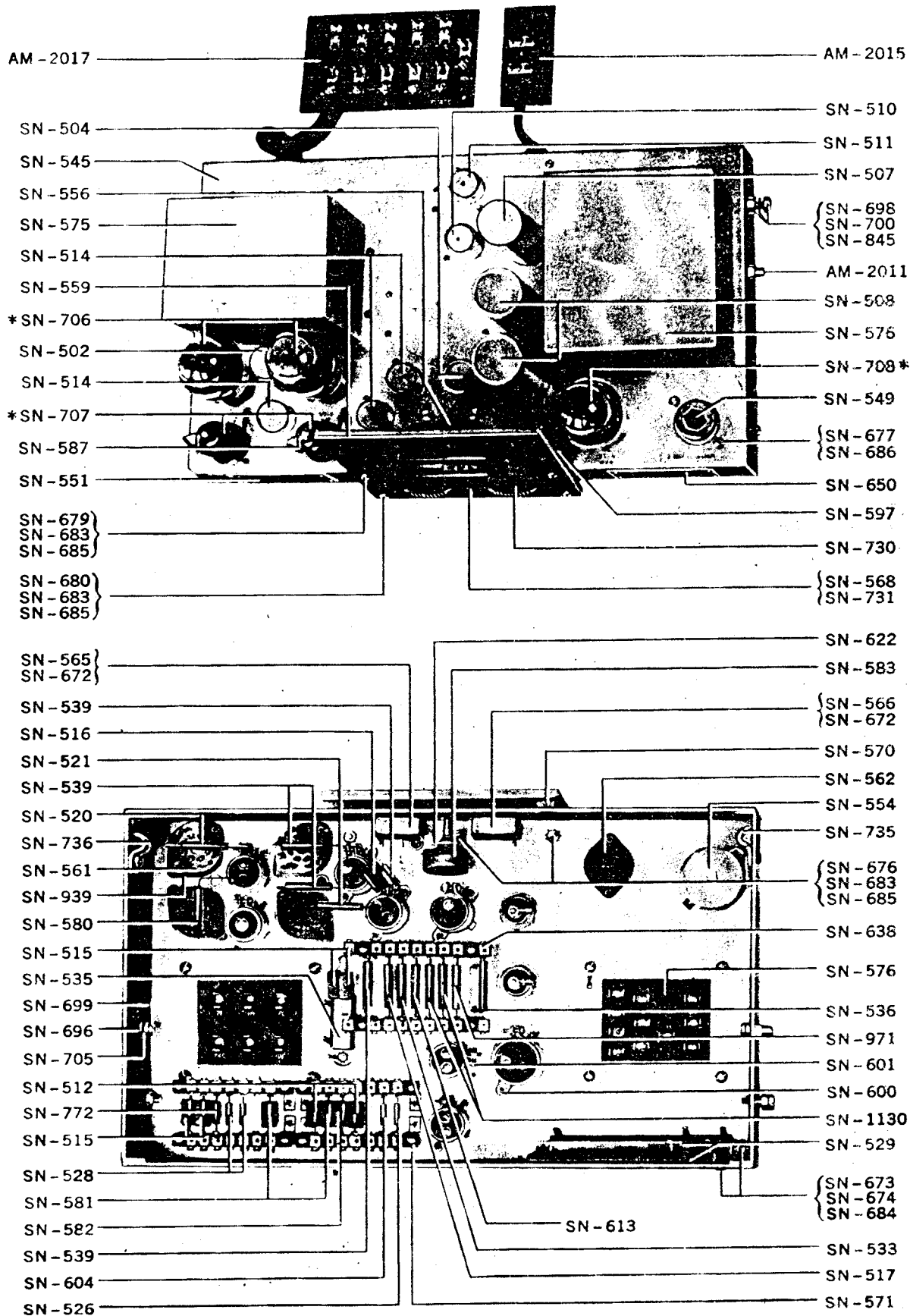

AM-1001 POWER AMPLIFIER

* INDICATES NON-COMPONENT ITEM
MUST BE ORDERED SEPARATELY

AM-1001 POWER AMPLIFIER

AM-2011	Roller (2)	SN-581	Capacitor (2)
AM-2015	Terminal Strip Assembly	SN-582	Capacitor
AM-2017	Terminal Strip Assembly	SN-583	Potentiometer
		SN-587	Grid Caps (2)
SN-502	Capacitor 25 Mfd 50 V	SN-597	Bracket (2)
SN-504	Capacitor 25 Mfd 25 V	SN-600	Clamping Ring
SN-507	Capacitor 4 @ 250 V, 20 @ 350	SN-601	Clamping Ring (7)
SN-508	Capacitor (2) 4 Mfd 600 V	SN-604	Resistor
SN-510	Capacitor .2 Mfd 200 V	SN-613	Resistor
SN-511	Capacitor .1 Mfd 200 V	SN-622	Bracket
SN-512	Capacitor (2) .0005 mfd 500 V	SN-638	Terminal Strip (2)
SN-514	Capacitor (3) .05 Mfd 400 V	SN-650	Name Plate
SN-515	Capacitor (4) .005 Mfd 500 V	SN-672	Screw (4-40 x 7/16) (4)
SN-516	Capacitor .0003 Mfd 500 V	SN-673	Screw (6-32 x 5-16) (6)
SN-517	Resistor	SN-674	Nut (6-32) (6)
SN-520	Resistor	SN-676	Screw (8-32 x 3/8) (6)
SN-521	Resistor	SN-677	Screw (8-32 x 1/2) (2)
SN-526	Resistor	SN-679	Screw (8-32 x 7/16) (2)
SN-528	Resistor (2)	SN-680	Screw (8-32 x 3/4) (2)
SN-529	Resistor (2)	SN-683	Nut (8-32) (10)
SN-533	Resistor	SN-684	Lockwasher (6)
SN-535	Resistor	SN-685	Lockwasher (10)
SN-536	Resistor	SN-686	Lockwasher (2)
SN-539	Resistor (4)	SN-696	Washer (2)
SN-545	Chassis	SN-698	Screw, Special (2)
SN-549	Fusetron	SN-699	Nut (10-32) (4)
SN-551	License Plate	SN-700	Spacer (2)
SN-554	Receptacle, Fuse	SN-705	Lockwasher (2)
SN-556	D.C. Milliammeter	*SN-706	Vacuum Tube Type 6L6G (2)
SN-559	Panel	*SN-707	Vacuum Tube Type 6J7 (2)
SN-561	Socket, Octal (4)	*SN-708	Vacuum Tube Type 5Z3
SN-562	Socket, 4 Prong	SN-730	Knob (2)
SN-565	Switch, D.P.D.T.	SN-731	Nut
SN-566	Switch, S.P.S.T.	SN-735	Cable Clamp
SN-568	Bushing	SN-736	Cable Clamp
SN-570	Spacer (2)	SN-772	Resistor
SN-571	Terminal Strip (4)	SN-845	Washer (2)
SN-575	Transformer, Output	SN-939	Insulator, Socket (4)
SN-576	Transformer, Power	SN-971	Resistor
SN-580	Resistor	SN-1130	Resistor (2)

* Indicates Non-Component Item
Must be ordered separately

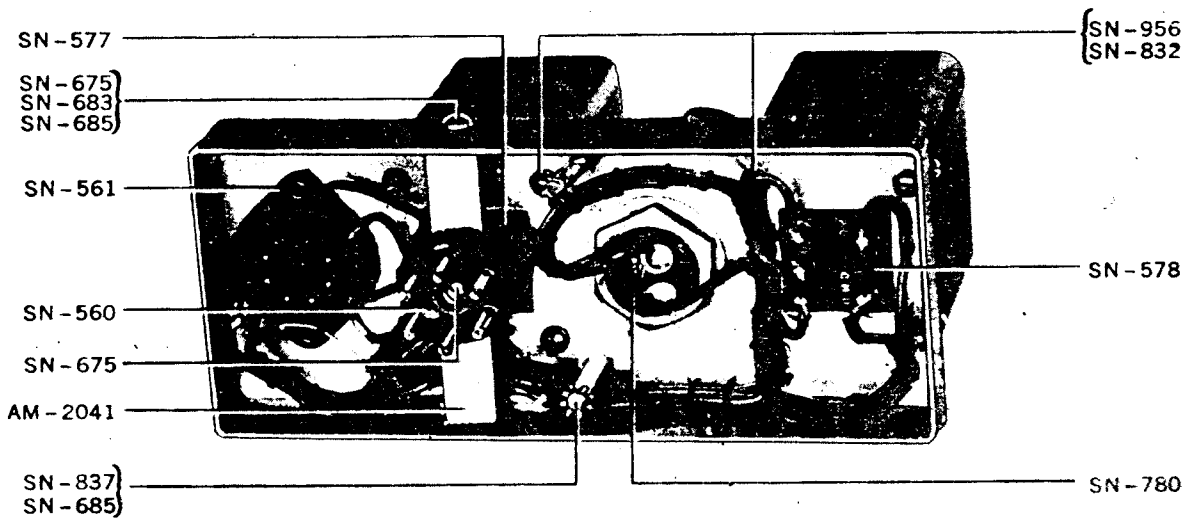
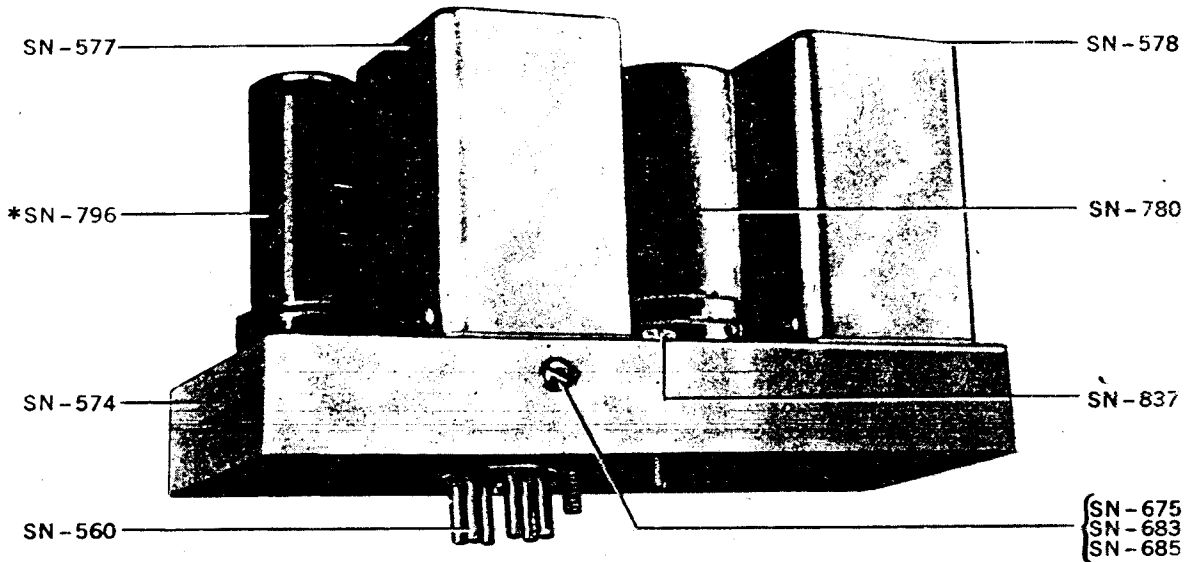

AM - 1003 MONITOR AMPLIFIER

* INDICATES NON - COMPONENT ITEM
MUST BE ORDERED SEPARATELY

AM-1003 MONITOR AMPLIFIER

AM-2041	Bracket
SN-560	Plug, 6 Prong
SN-561	Socket, Octal
SN-574	Chassis
SN-577	Transformer, Input
SN-578	Transformer, Output
SN-675	Screw (8-32 x 1/4) (3)
SN-683	Nut (8-32) (2)
SN-685	Lockwasher (4)
SN-780	Capacitor
*SN-796	Vacuum Tube Type 6N7
SN-832	Lockwasher (8)
SN-837	Screw (10-32 x 1-1/4) (2)
SN-956	Screw (6-32 x 1/4) (8)

* Indicates Non-Component Item
Must be ordered separately

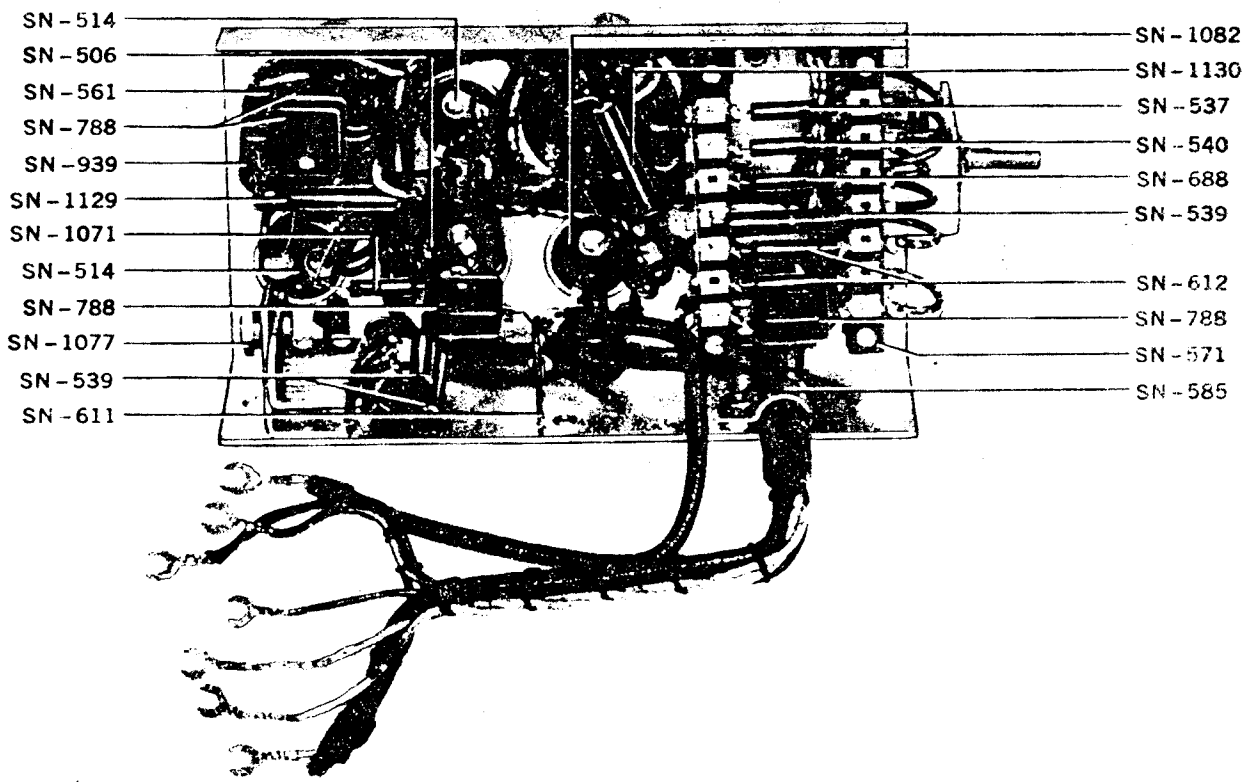
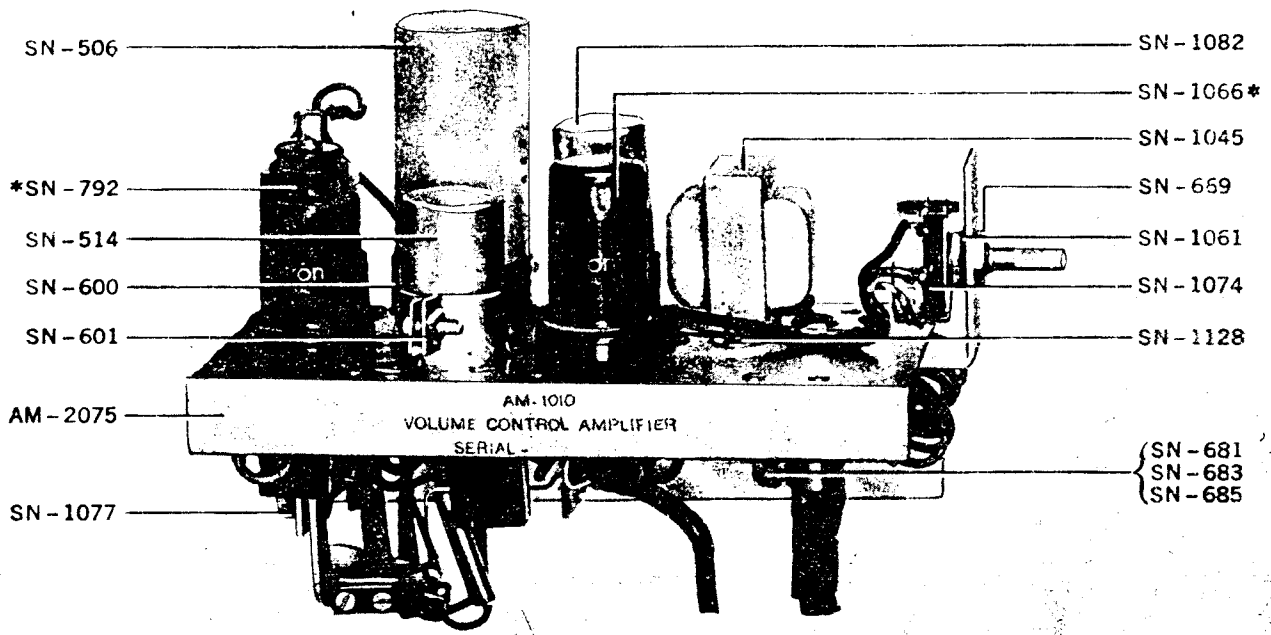

AM-1010 VOLUME CONTROL AMPLIFIER

*INDICATES NON-COMPONENT ITEM
MUST BE ORDERED SEPARATELY

AM-1010 VOLUME CONTROL AMPLIFIER

AM-2075	Chassis
SN-506	Capacitor
SN-514	Capacitor (2)
SN-537	Resistor
SN-539	Resistor (3)
SN-540	Resistor
SN-561	Socket, Octal (2)
SN-571	Terminal Strip (2)
SN-585	Cable Clamp
SN-600	Clamping Ring
SN-601	Clamping Ring (3)
SN-611	Terminal Strip
SN-612	Resistor (2)
SN-669	Nut (3/8-32)
SN-681	Screw (8-32 x 3/8)
SN-683	Nut (8-32)
SN-685	Lockwasher
SN-688	Resistor
SN-788	Capacitor (4)
*SN-792	Vacuum Tube Type 6J7 (B-31 Stock)
SN-939	Insulator, Socket (2)
SN-1045	Reactor
SN-1061	Lockwasher (2)
*SN-1066	Vacuum Tube Type 6SJ7
SN-1071	Resistor
SN-1074	Potentiometer
SN-1077	Jack
SN-1082	Capacitor
SN-1128	Screw (2)
SN-1129	Resistor
SN-1130	Resistor

* Indicates Non-Component Item
Must be ordered separately

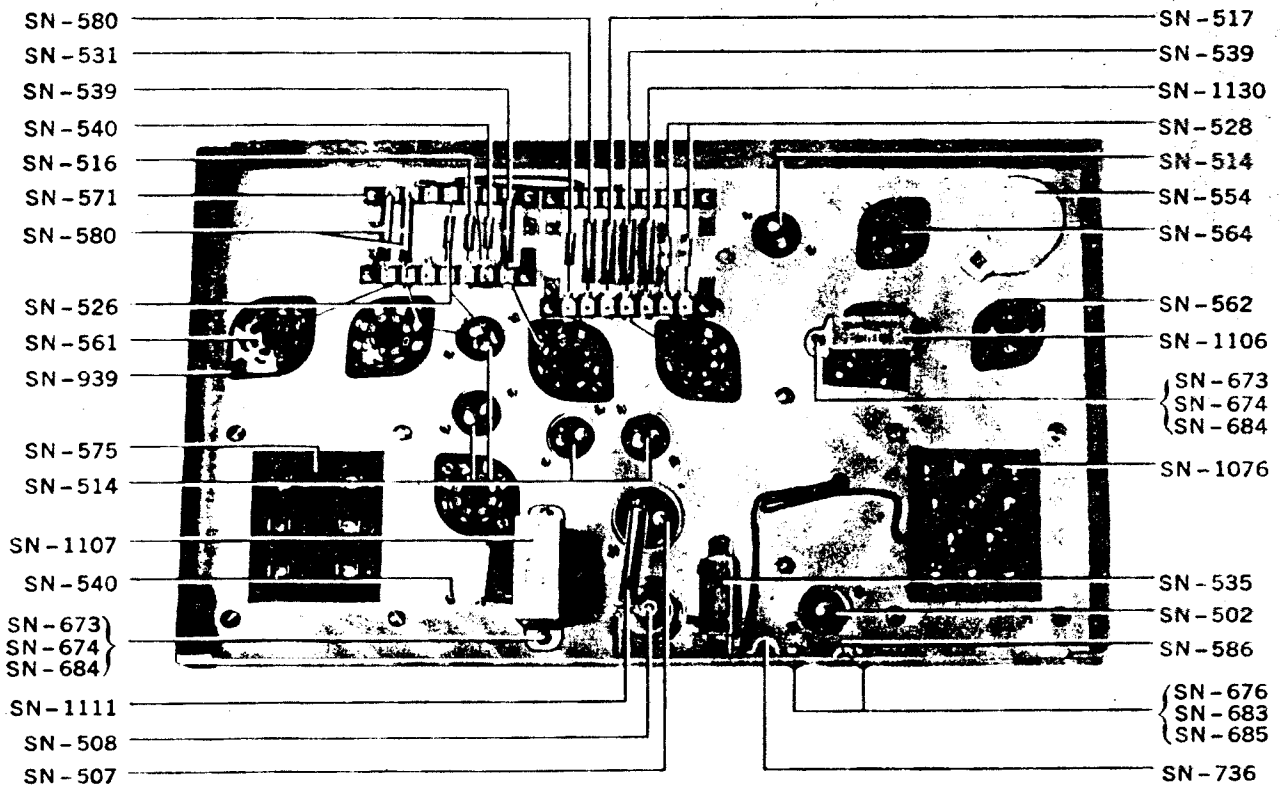
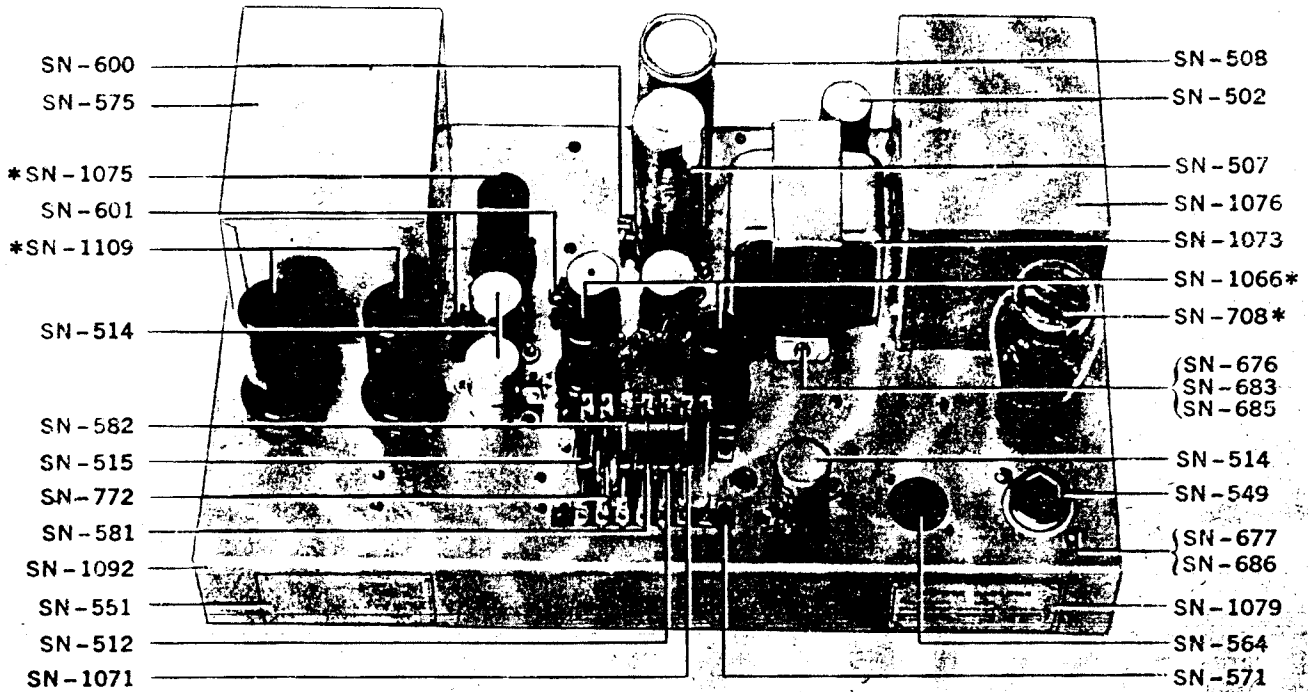

AM-1011 POWER AMPLIFIER

*INDICATES NON-COMPONENT ITEM.
MUST BE ORDERED SEPARATELY

AM-1011 POWER AMPLIFIER

SN-502	Capacitor
SN-507	Capacitor
SN-508	Capacitor
SN-512	Capacitor
SN-514	Capacitor (5)
SN-515	Capacitor
SN-516	Capacitor
SN-517	Resistor
SN-526	Resistor
SN-528	Resistor (2)
SN-531	Resistor
SN-535	Resistor
SN-539	Resistor (2)
SN-540	Resistor (2)
SN-549	Fusetron
SN-551	License Plate
SN-554	Fuse Receptacle
SN-561	Socket, Octal (5)
SN-562	Socket, 4 Prong
SN-564	Socket, 6 Prong
SN-571	Terminal Strip (6)
SN-575	Transformer, Output
SN-580	Resistor (3)
SN-581	Capacitor
SN-582	Capacitor
SN-586	Cable Clamp
SN-600	Clamping Ring
SN-601	Clamping Ring (6)
SN-673	Screw (6-32 x 5/16) (4)
SN-674	Nut (6-32) (4)
SN-676	Screw (8-32 x 3/8) (4)
SN-677	Screw (8-32 x 1/2) (2)
SN-683	Nut (8-32) (4)
SN-684	Lockwasher (4)
SN-685	Lockwasher (4)
SN-686	Lockwasher (2)
*SN-708	Vacuum Tube Type 5Z3
SN-736	Cable Clamp
SN-772	Resistor
SN-939	Insulator, Socket (5)
*SN-1066	Vacuum Tube Type 6SJ7 (2)
SN-1071	Resistor
SN-1073	Reactor
*SN-1075	Vacuum Tube Type 6F6
SN-1076	Transformer, Power
SN-1079	Name Plate
SN-1092	Chassis
SN-1106	Transformer, Output
SN-1107	Transformer, Input
*SN-1109	Vacuum Tube Type 6L6 (2)
SN-1111	Resistor
SN-1130	Resistor

* Indicates Non-Component Item
Must be ordered separately

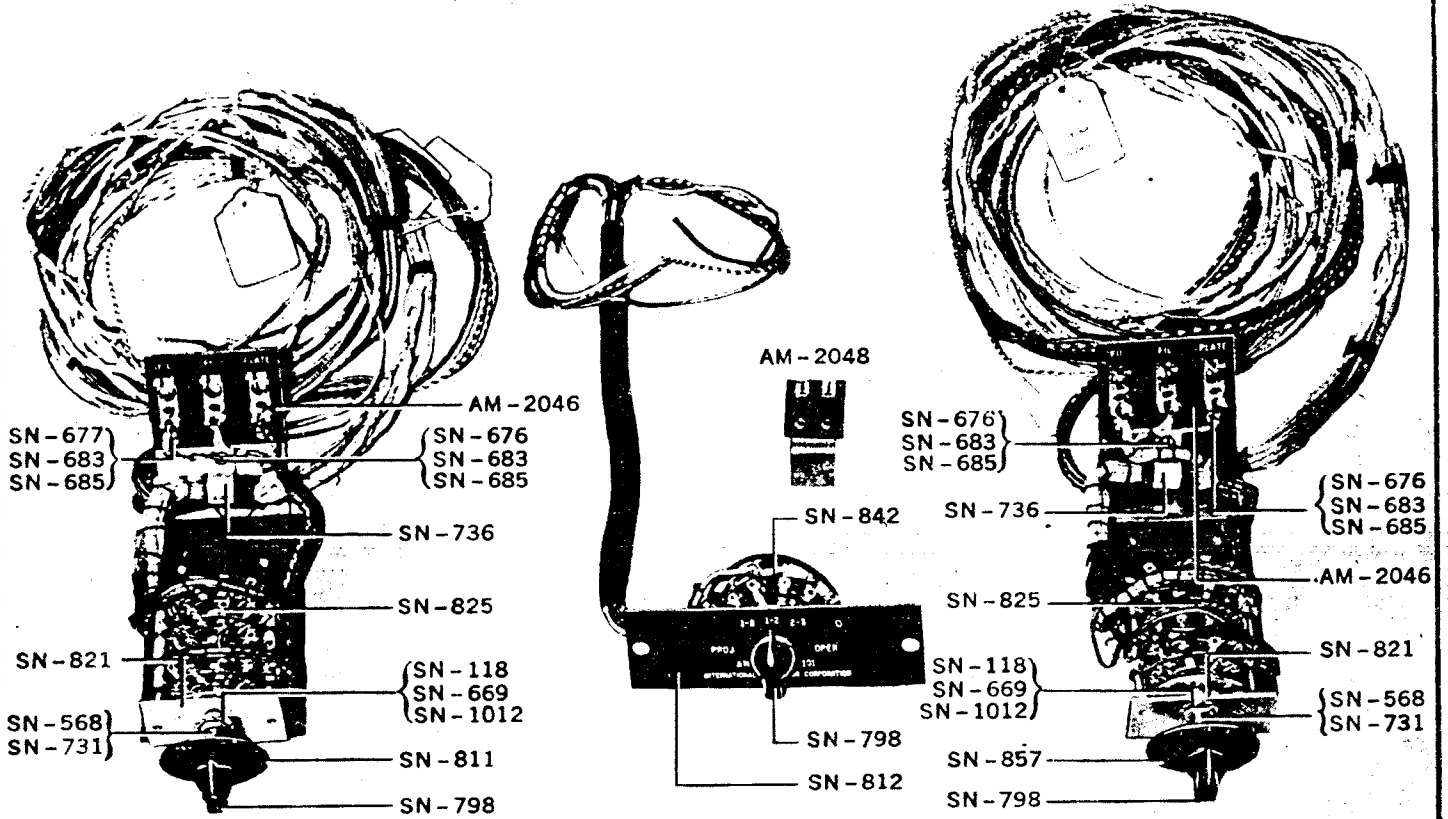

AM-2013 SWITCH

AM-2047 SWITCH

AM-2049 SWITCH

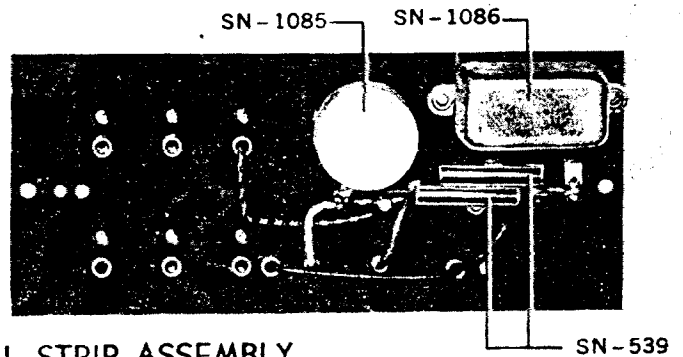
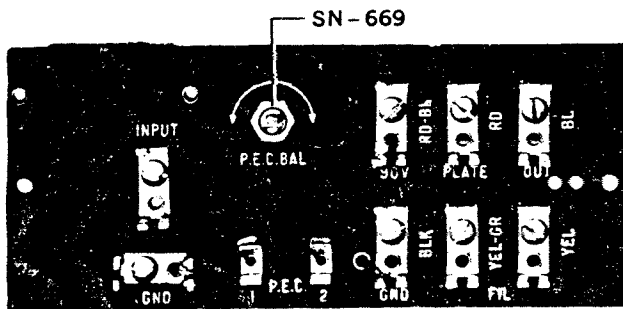

AM-2074 TERMINAL STRIP ASSEMBLY

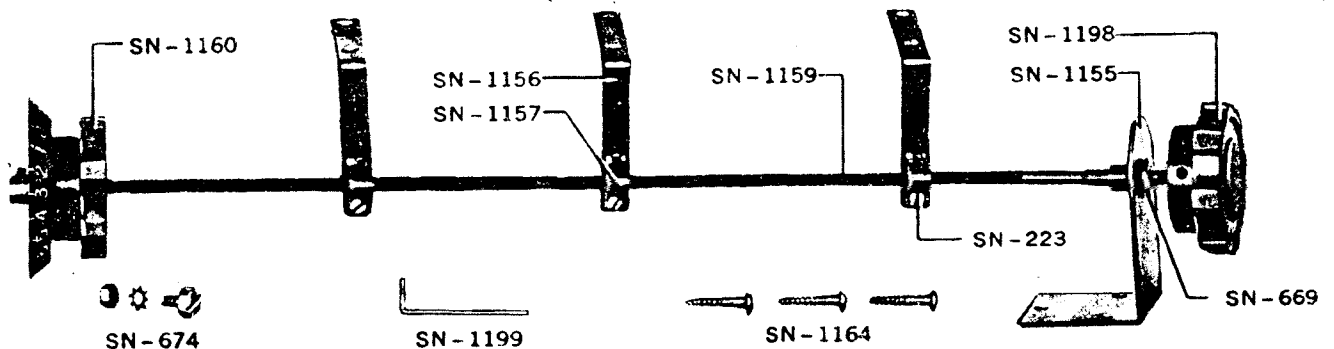

SN-674
SN-684
SN-1298

AM-2082 EXTENSION VOLUME CONTROL

AM-2013 SWITCH

AM-2049 SWITCH

AM-2046	Terminal Strip Assembly
SN-118	Washer
SN-568	Bushing
SN-669	Nut (3/8-32)
SN-676	Screw (8-32 x 3/8)
SN-677	Screw (8-32 x 1/2) (2)
SN-683	Nut (8-32) (3)
SN-685	Lockwasher (3)
SN-731	Nut
SN-736	Cable Clamp
SN-798	Knob
SN-811	Dial Plate (AM-2013 Only)
SN-821	Bracket
SN-825	Switch
SN-857	Dial Plate (AM-2049 Only)
SN-1012	Lockwasher

AM-2047 THIRD MACHINE SWITCH

AM-2048	Terminal Strip Assembly
SN-798	Knob
SN-812	Name Plate
SN-842	Switch

AM-2074 TERMINAL STRIP ASSEMBLY

SN-539	Resistor (2)
SN-669	Nut (3/8-32) (2)
SN-1085	Potentiometer
SN-1086	Capacitor

AM-2082 EXTENSION VOLUME CONTROL

SN-223	Screw (8-32 x 1/4) (3)
SN-669	Nut (3/8-32)
SN-674	Nut (6-32)
SN-684	Lockwasher
SN-1155	Bracket
SN-1156	Bracket (3)
SN-1157	Clamp (3)
SN-1159	Shaft
SN-1160	Knob
SN-1164	Wood Screw (10 x 1") (9)
SN-1198	Knob
SN-1199	Wrench
SN-1298	Indicator

SN-674 }
 SN-704 }
 SN-1020 }

SN-683 }
 SN-743 }
 SN-762 }

SN-868

AM-2004

SN-762 }
 SN-763 }

SN-703

{ SN-674
 { SN-684
 { SN-1059 }

SN-761

{ SN-683
 { SN-696 }

AM-2008

AM-2009

{ SN-654
 { SN-669 }

SN-658

AM-2023 CABINET

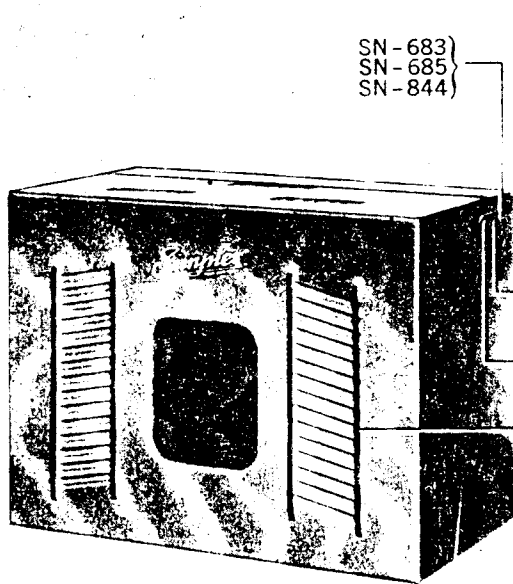

SN-683 }
 SN-685 }
 SN-844 }

SN-704 }
 SN-1058 }

SN-683 }
 SN-696 }

SN-1056

AM-2043

SN-843

{ SN-683
 { SN-685
 { SN-844
 { SN-845 }

SN-1057

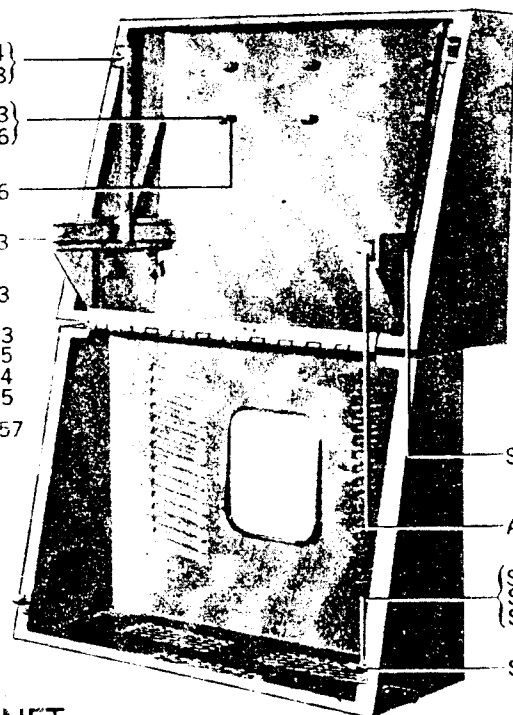

SN-681

AM-2042

{ SN-674
 { SN-684
 { SN-1059 }

SN-703

AM-2033 CABINET

AM-2023 CABINET

AM-2004	Door
AM-2008	Slide, Left (3)
AM-2009	Slide, Right (3)
SN-654	Apparatus Blank (3)
SN-658	Panel
SN-669	Nut (3/8-32) (3)
SN-674	Nut (6-32) (8)
SN-683	Nut (8-32) (24)
SN-684	Lockwasher (4)
SN-696	Washer (36)
SN-703	Door Strike (2)
SN-704	Door Catch (2)
SN-743	Screw (8-32 x 3/8) (4)
SN-761	Spacer (18)
SN-762	Cup Washer (8)
SN-763	Screw (8-32 x 1-1/4) (4)
SN-868	Moulding Strip (4)
SN-1020	Screw (6-32 x 5/16) (4)
SN-1059	Screw (6-32 x 1/4) (4)

AM-2033 CABINET

AM-2042	Slide, Right
AM-2043	Slide, Left
SN-674	Nut (6-32) (4)
SN-681	Screw (8-32 x 3/8) (2)
SN-683	Nut (8-32) (10)
SN-684	Lockwasher (4)
SN-685	Lockwasher (4)
SN-696	Washer (12)
SN-703	Door Strike (2)
SN-704	Door Catch (2)
SN-843	Link (2)
SN-844	Screw, Special (4)
SN-845	Washer (2)
SN-1056	Spacer (6)
SN-1057	Moulding Strip (4)
SN-1058	Screw (6-32 x 1/4) (4)
SN-1059	Screw (6-32 x 1/4) (4)

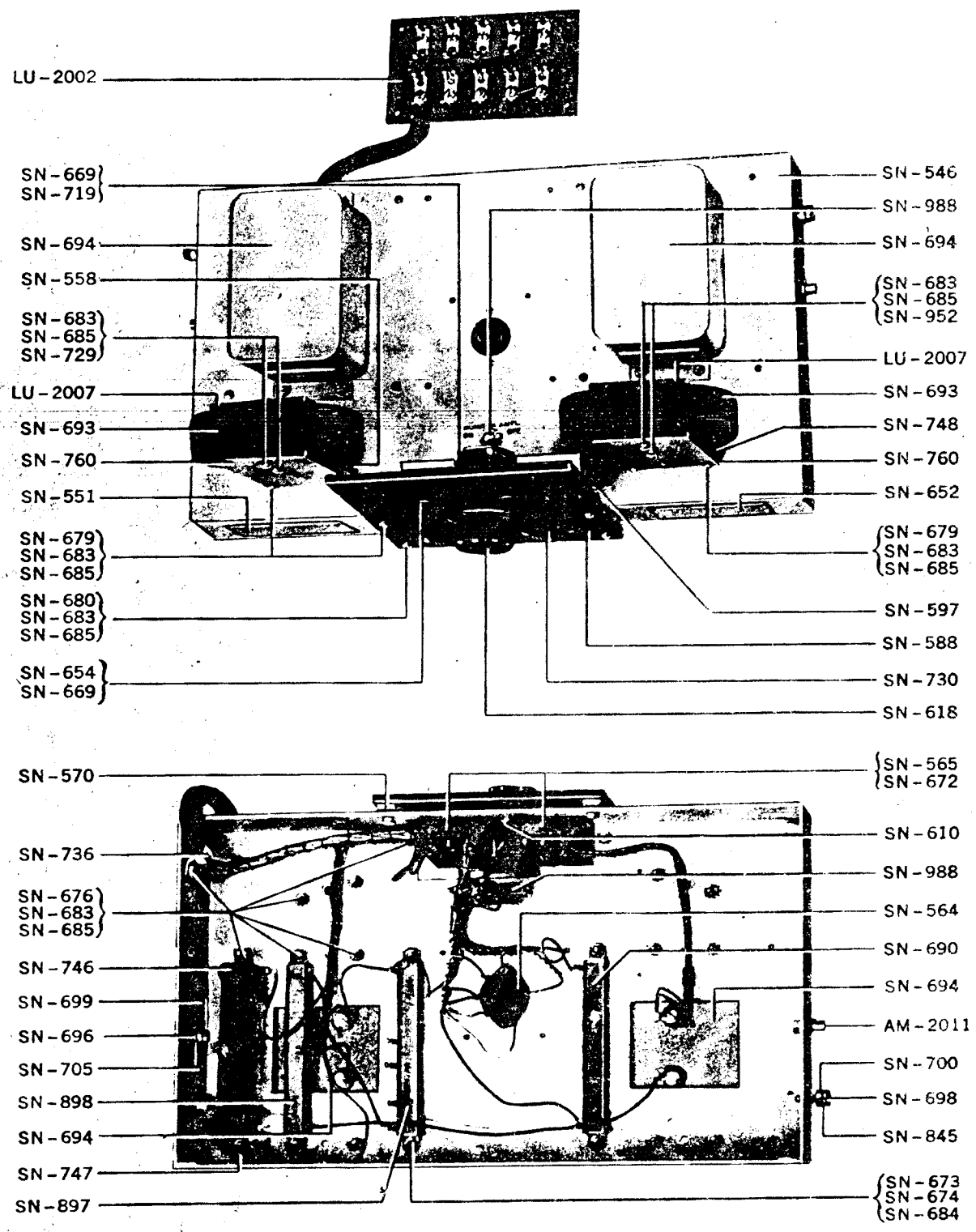

LU-1002 NETWORK

LU-1002 NETWORK

LU-2002	Terminal Strip Assembly
LU-2007	Support, Rear (2)
AM-2011	Roller (2)
SN-546	Chassis
SN-551	License Plate
SN-558	Bracket, Left Mounting
SN-564	Socket, G Prong
SN-565	Switch, D.P.D.T. (2)
SN-570	Spacer, Panel (2)
SN-588	Panel
SN-597	Bracket, Panel Mounting (2)
SN-610	Jack
SN-618	Knob, Rheostat
SN-652	Name Plate
SN-654	Apparatus Blank (2)
SN-669	Nut (3/8-32) (4)
SN-672	Screw (4-40 x 7/16) (4)
SN-673	Screw 6-32 x 5/16) (4)
SN-674	Nut (6-32) (4)
SN-676	Screw (8-32 x 3/8) (17)
SN-679	Screw (8-32 x 7/16) (10)
SN-680	Screw (8-32 x 3/4) (2)
SN-683	Nut (8-32) (33)
SN-684	Lockwasher (4)
SN-685	Lockwasher (33)
SN-690	Resistor
SN-693	Reactor (2)
SN-694	Capacitor (2)
SN-696	Washer (2)
SN-698	Screw, Special (2)
SN-699	Nut (10-32) (4)
SN-700	Spacer (2)
SN-705	Lockwasher (2)
SN-719	Rheostat
SN-729	Screw (8-32 x 1-3/4 Brass) (2)
SN-730	Knob, Switch (2)
SN-736	Cable Clamp
SN-746	Resistor
SN-747	Bracket, Resistor Mounting (2)
SN-748	Bracket, Right Mounting
SN-760	Support, Front (2)
SN-845	Washer (2)
SN-897	Resistor
SN-898	Resistor
SN-952	Screw (8-32 x 1-3/4 Iron) (2)
SN-988	Switch, D.P.D.T.

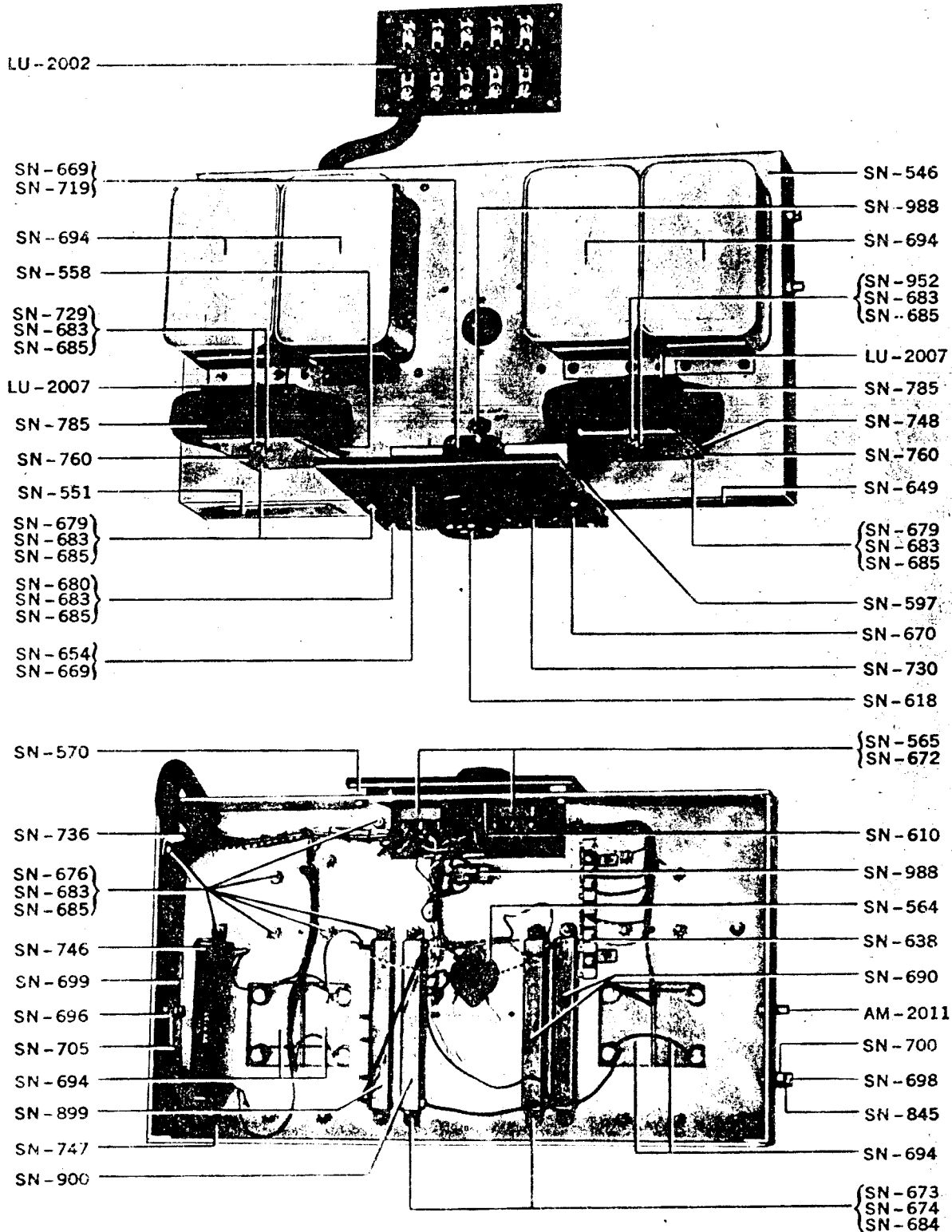

LU-1003 NETWORK

LU-1003 NETWORK

LU-2002	Terminal Strip Assembly
LU-2007	Support, Rear (2)
AM-2011	Roller (2)
SN-546	Chassis
SN-551	License Plate
SN-558	Bracket, Left Mounting
SN-564	Socket, 6 Prong
SN-565	Switch, D.P.D.T. (2)
SN-570	Spacer, Panel (2)
SN-597	Bracket, Panel Mounting (2)
SN-610	Jack
SN-618	Knob, Rheostat
SN-638	Terminal Strip
SN-649	Name Plate
SN-654	Apparatus Blank (2)
SN-669	Nut (3/8-32) (4)
SN-670	Panel
SN-672	Screw (4-40 x 7/16) (4)
SN-673	Screw (6-32 x 5/16) (4)
SN-674	Nut (6-32) (4)
SN-676	Screw (8-32 x 3/8) (23)
SN-679	Screw (8-32 x 7/16) (10)
SN-680	Screw (8-32 x 3/4) (2)
SN-683	Nut (8-32) (39)
SN-684	Lockwasher (4)
SN-685	Lockwasher (39)
SN-690	Resistor (2)
SN-694	Capacitor (4)
SN-696	Washer (2)
SN-698	Screw, Special (2)
SN-699	Nut (10-32) (4)
SN-700	Spacer (2)
SN-705	Lockwasher (2)
SN-719	Rheostat
SN-729	Screw (8-32 x 1-3/4 Brass) (2)
SN-730	Knob, Switch (2)
SN-736	Cable Clamp
SN-746	Resistor
SN-747	Bracket, Resistor Mounting (2)
SN-748	Bracket, Right Mounting
SN-760	Support, Front (2)
SN-785	Reactor (2)
SN-845	Washer (2)
SN-899	Resistor
SN-900	Resistor
SN-952	Screw (8-32 x 1-3/4 Iron) (2)
SN-988	Switch, D.P.D.T.

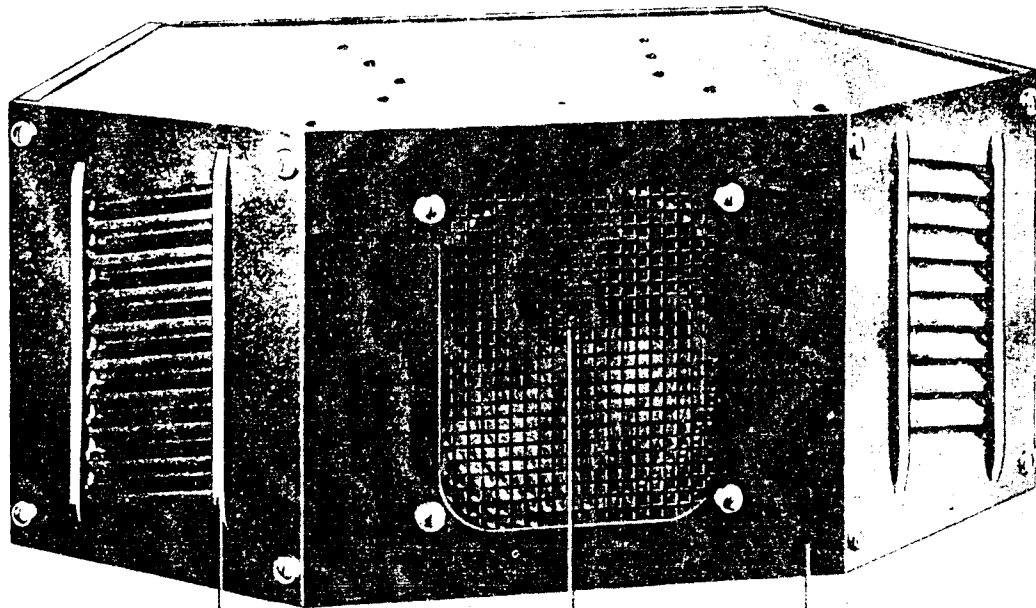

SN-784

LU-1018

LU-1024

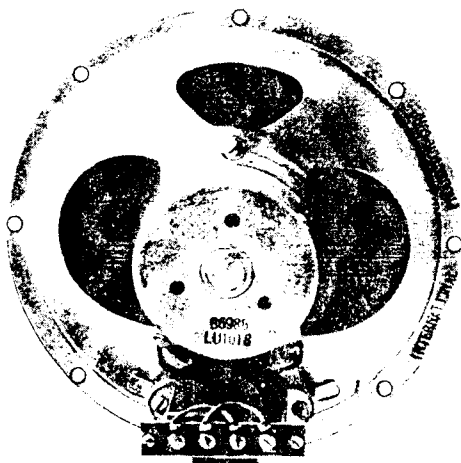

LU-1018

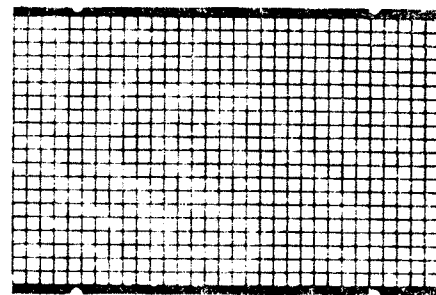

SN-856

SN-1134

SN-699

SN-705



SN-875



SN-713



SN-875



SN-713



SN-714

LU-1018 MONITOR UNIT
LU-1024 MONITOR HORN

LU-1018 MONITOR UNIT

LU-1024 MONITOR HORN

SN-699	Nut (10-32) (9)
SN-705	Lockwasher (9)
SN-713	Mounting Angle (2)
SN-714	Mounting Bracket
SN-784	Moulding (4)
SN-856	Grill
SN-875	Adjustable Leg
SN-1134	Screw (10-32 x 1/2) (9)

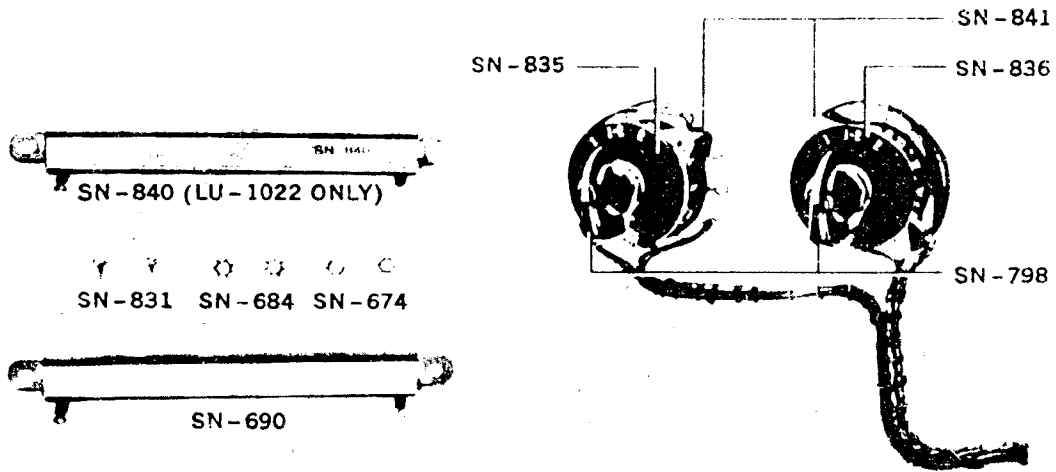

LU-1022 SWITCH
LU-1044 SWITCH

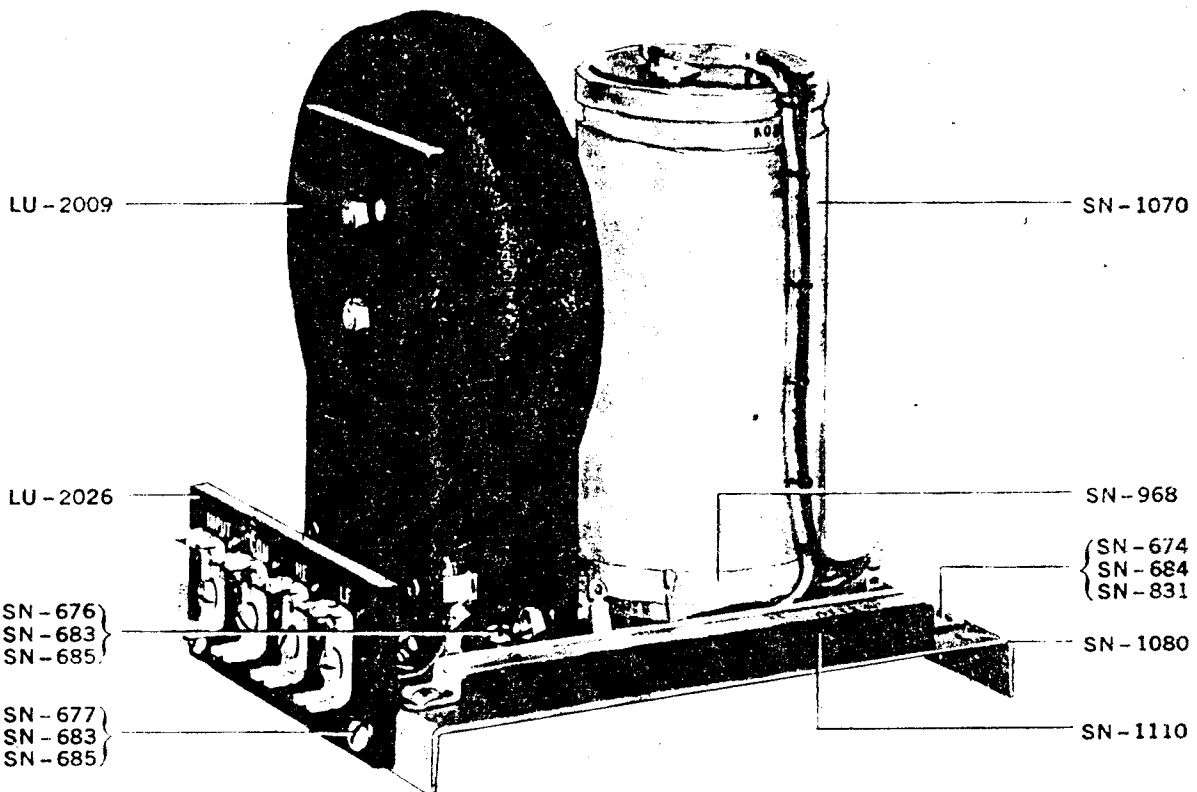

LU-1047 NETWORK

LU-1022 SWITCH

LU-1044 SWITCH

SN-674	Nut (6-32) (2)
SN-684	Lockwasher (2)
SN-690	Resistor
SN-798	Knob (2)
SN-831	Screw (6-32 x 3/8) (2)
SN-835	Dial Plate (HF)
SN-836	Dial Plate (LF)
SN-840	Resistor (LU-1022 Only)
SN-841	Switch (2)

* LU-1022 - One Required

LU-1044 - Two Required

LU-1047 NETWORK

LU-2009	Reactor Assembly
LU-2026	Terminal Strip Assembly
SN-674	Nut (6-32) (2)
SN-676	Screw (8-32 x 3/8) (2)
SN-677	Screw (8-32 x 1/2) (2)
SN-683	Nut (8-32) (4)
SN-684	Lockwasher (2)
SN-685	Lockwasher (4)
SN-831	Screw (6-32 x 3/8) (2)
SN-968	Clamping Ring
SN-1070	Capacitor
SN-1080	Chassis
SN-1110	Resistor

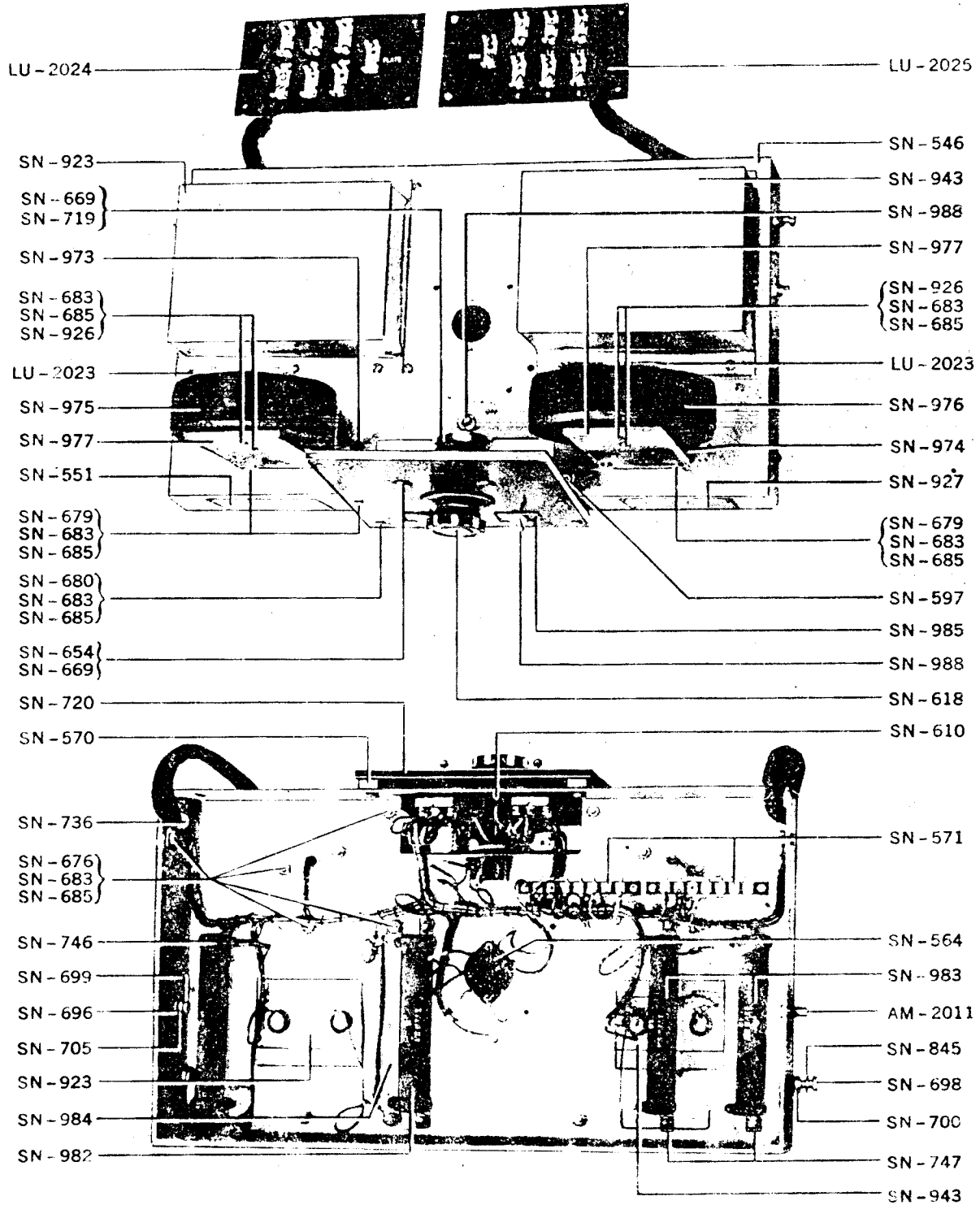

LU-1026 NETWORK

LU-1026 NETWORK

LU-2023	Support, Rear (2)
LU-2024	Terminal Strip Assembly, Input
LU-2025	Terminal Strip Assembly, Output
AM-2011	Roller (2)
SN-546	Chassis
SN-551	License Plate
SN-564	Socket, 6 Prong
SN-570	Spacer, Panel (2)
SN-571	Terminal Strip (2)
SN-597	Bracket, Panel Mounting (2)
SN-610	Jack
SN-618	Knob, Rheostat
SN-654	Apparatus Blank (2)
SN-669	Nut (3/8-32) (4)
SN-676	Screw (8-32 x 3/8) (22)
SN-679	Screw (8-32 x 7/16) (10)
SN-680	Screw (8-32 x 3/4) (2)
SN-683	Nut (8-32) (38)
SN-685	Lockwasher (38)
SN-696	Washer (2)
SN-698	Screw, Special (2)
SN-699	Nut (10-32) (4)
SN-700	Spacer (2)
SN-705	Lockwasher (2)
SN-719	Rheostat
SN-720	Panel
SN-736	Cable Clamp (2)
SN-746	Resistor
SN-747	Bracket, Resistor Mounting (8)
SN-845	Washer (2)
SN-923	Capacitor
SN-926	Screw (8-32 x 2-5/16 Brass) (4)
SN-927	Name Plate
SN-943	Capacitor
SN-973	Bracket, Left Mounting
SN-974	Bracket, Right Mounting
SN-975	Reactor
SN-976	Reactor
SN-977	Support, Front, (2)
SN-982	Resistor
SN-983	Resistor (2)
SN-984	Resistor
SN-985	Plate, Switch Mounting (2)
SN-988	Switch, D.P.D.T. (3)

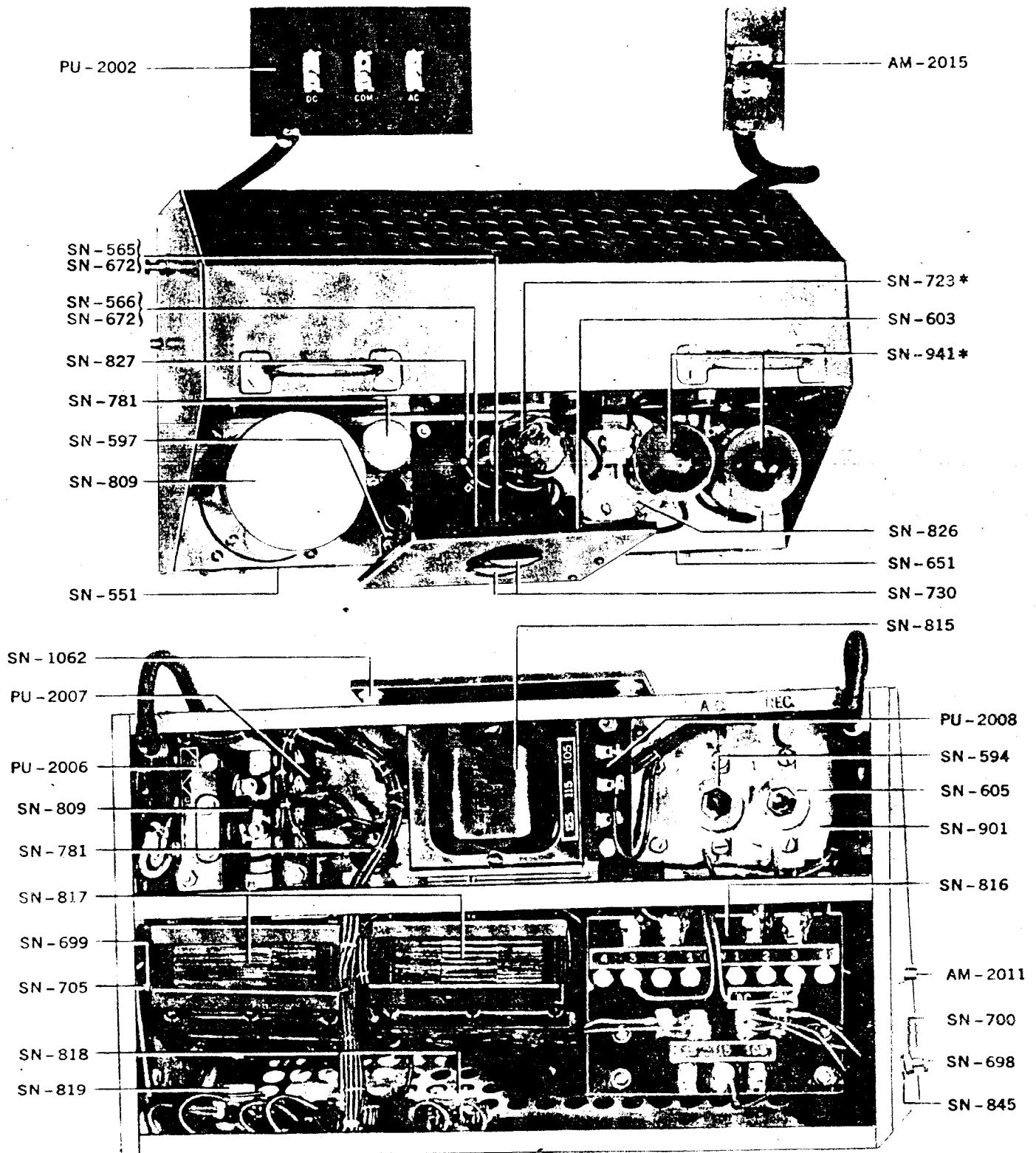

PU - 1000 POWER UNIT

* INDICATES NON-COMPONENT ITEM
MUST BE ORDERED SEPARATELY

PU-1000 POWER UNIT

PU-2002	Terminal Strip Assembly
PU-2006	Terminal Strip Assembly
PU-2007	Terminal Strip Assembly
PU-2008	Terminal Strip Assembly
AM-2011	Roller (2)
AM-2015	Terminal Strip Assembly
SN-551	License Plate
SN-565	Switch, D.P.D.T. Slide
SN-566	Switch, S.P.S.T. Slide
SN-594	Fusetron, 1 Amp.
SN-597	Bracket, Panel Mounting (2)
SN-603	Panel
SN-605	Fusetron, 3.2 Amp.
SN-651	Name Plate
SN-672	Screw (4-40 x 7/16) (4)
SN-698	Screw, Special (2)
SN-699	Nut (10-32) (2)
SN-700	Spacer (2)
SN-705	Lockwasher (2)
*SN-723	Ballast Lamp
SN-730	Knob, Switch (2)
SN-781	Capacitor
SN-809	Capacitor
SN-815	Transformer, Power
SN-816	Transformer, Power
SN-817	Reactor (2)
SN-818	Rheostat (2)
SN-819	Rheostat
SN-826	Socket, Porcelain (2)
SN-827	Socket, 4 Prong
SN-845	Washer (2)
SN-901	Receptacle, Fuse
*SN-941	Tungar Bulb (2)
SN-987	Switch, D.P.S.T. Toggle
SN-1051	Switch, D.P.D.T. Toggle
SN-1062	Spacer, Panel (2)

* Indicates Non-Component Item
Must be ordered separately

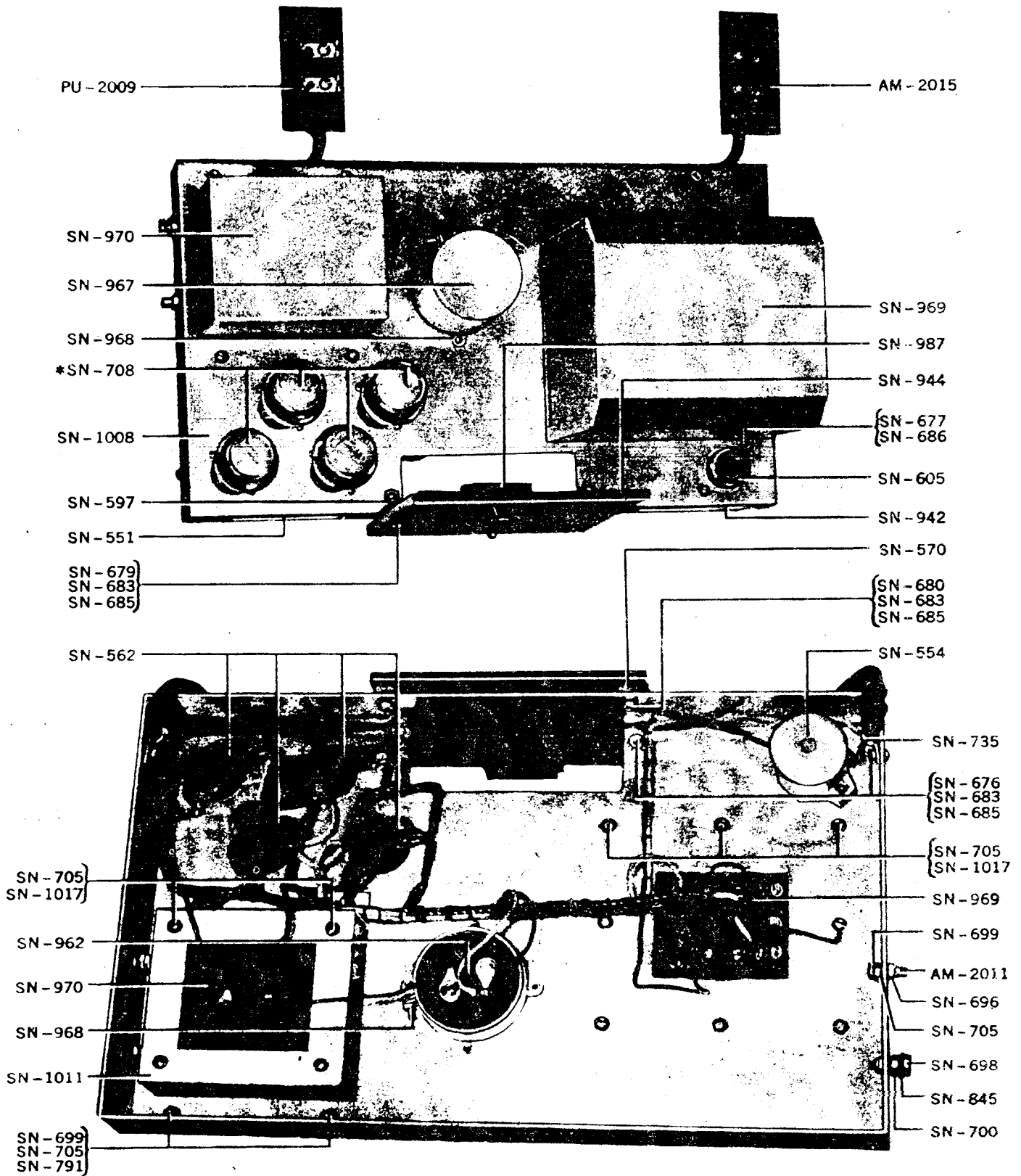

PU-1003 POWER UNIT

* INDICATES NON-COMPONENT ITEM
MUST BE ORDERED SEPARATELY

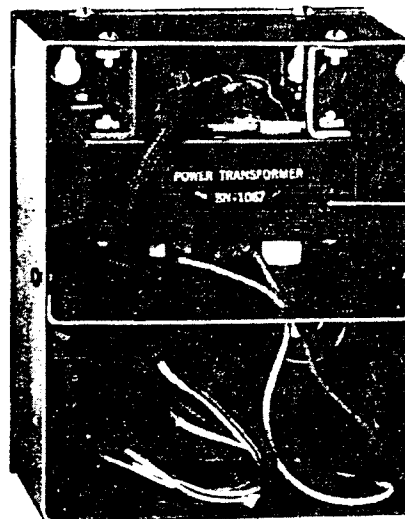
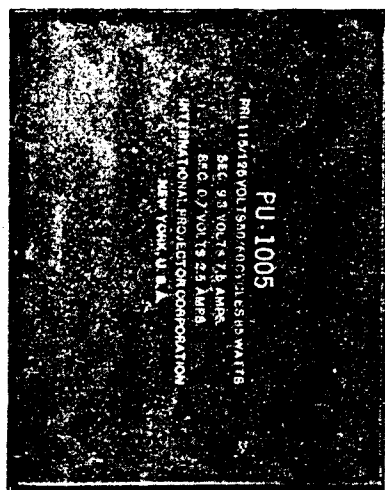

SN-1067

PU-1005 POWER UNIT

PU-1003 POWER UNIT

PU-2009	Terminal Strip Assembly	SN-698	Screw, Special (2)
AM-2011	Roller (2)	SN-699	Nut (10-32) (8)
AM-2015	Terminal Strip Assembly	SN-700	Spacer (2)
		SN-705	Lockwasher (18)
SN-551	License Plate	*SN-708	Vacuum Tube Type 5Z3 (4)
SN-554	Receptacle, Fuse	SN-735	Cable Clamp (2)
SN-562	Socket, 4 Prong (4)	SN-791	Screw (10-32 x 1/2) (4)
SN-570	Spacer (2)	SN-845	Washer (2)
SN-597	Bracket (2)	SN-942	Name Plate
SN-605	Fusetron	SN-944	Panel
SN-676	Screw (8-32 x 3/8) (4)	SN-967	Capacitor
SN-677	Screw (8-32 x 1/2) (2)	SN-968	Clamping Ring (2)
SN-679	Screw (8-32 x 7/16) (2)	SN-969	Transformer, Power
SN-680	Screw (8-32 x 3/4) (2)	SN-970	Reactor
SN-683	Nut (8-32) (8)	SN-987	Switch, D.P.S.T.
SN-685	Lockwasher (8)	SN-1008	Chassis
SN-686	Lockwasher (4)	SN-1011	Bracket (2)
SN-696	Washer (2)	SN-1017	Screw (10-32 x 5/8) (12)

PU-1005 POWER UNIT

SN-1067

Transformer

* Indicates Non-Component Item
Must be ordered separately