

# Film-Tech

The information contained in this Adobe Acrobat pdf file is provided at your own risk and good judgment.

These manuals are designed to facilitate the exchange of information related to cinema projection and film handling, with no warranties nor obligations from the authors, for qualified field service engineers.

If you are not a qualified technician, please make no adjustments to anything you may read about in these Adobe manual downloads.

[www.film-tech.com](http://www.film-tech.com)

# SPECO

## Drive-in Theater Speaker & Junction Box Replacement Parts & Tools List

Includes parts for: RCA, CBX, MARK 2, & Simplex brand speakers and RCA old style and "Circlite" (New Style) junction boxes.

Speco

Systems & Products Engineering Co.

(Formerly known as Drive-in Theater Mfg Co. Inc.)

709 North 6th Street

Kansas City, Kansas 66101

1-800-633-5913

(913) 321-3978 voice

(913) 321-7439 fax

e-mail: [info@speco-usa.com](mailto:info@speco-usa.com)

# SPEAKERS...

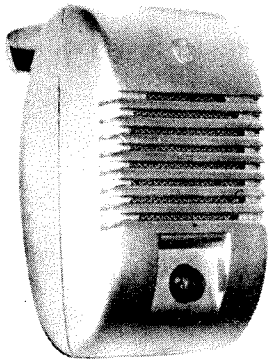

RCA

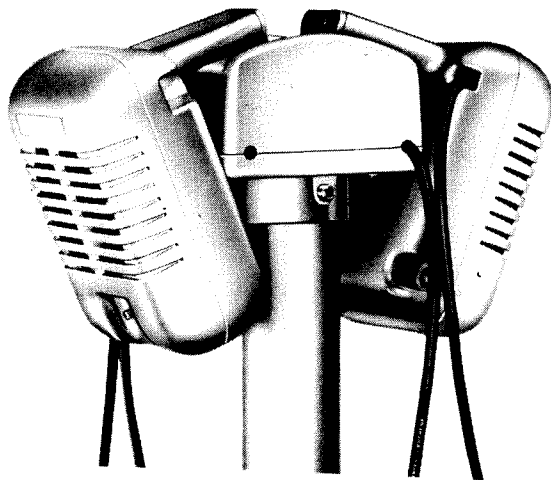

MARK II

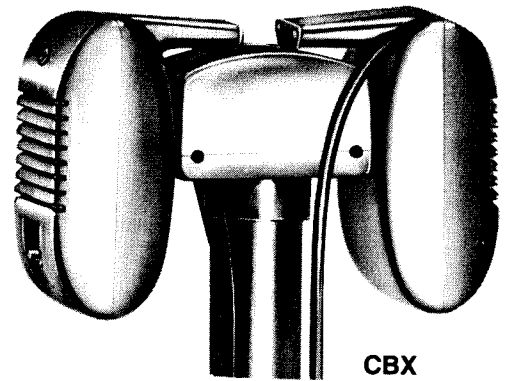

CBX

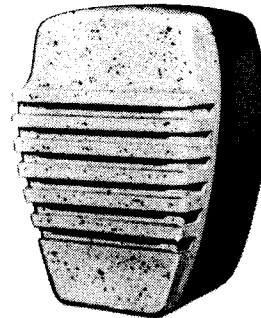

STANDEE

# ...JUNCTION BOXES

CIRCLITE  
JUNCTION BOX

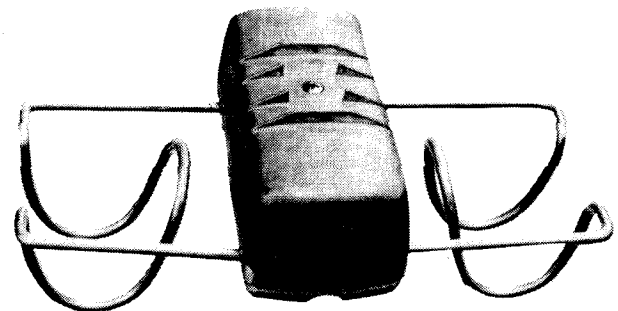
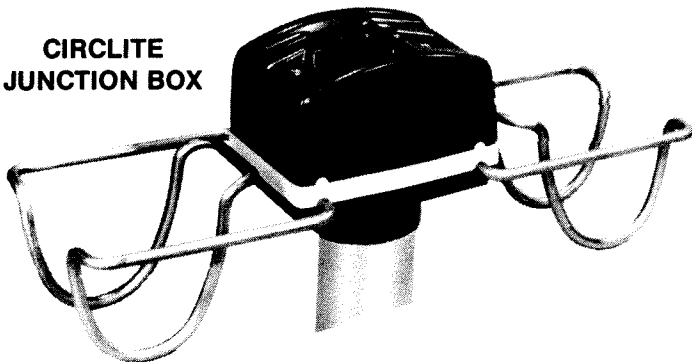

RCA OLD STYLE  
JUNCTION BOX

# REPLACEMENT PARTS

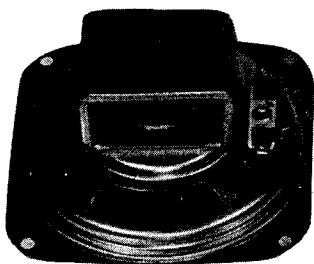

SPEAKER UNITS

DRIVE-IN  
*theatre* MFG. CO., INC.

709 North Sixth Street  
Kansas City, Kansas 66101  
(913) 321-3978

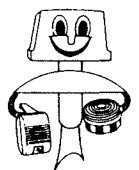

# STOCK NUMBERS

CBX  
**MARK II**

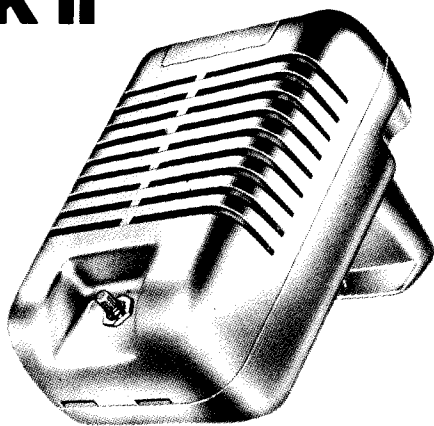

## IN-CAR SPEAKER

**Painted**

- 9215 with straight cord
- ~~9216 with coiled cord~~
- 9217 with theftproof cord
- 9219 less cord

**Unpainted**

- 9210 with straight cord
- ~~9211 with coiled cord~~
- 9212 with theft proof cord
- 9214 less cord

## RCA

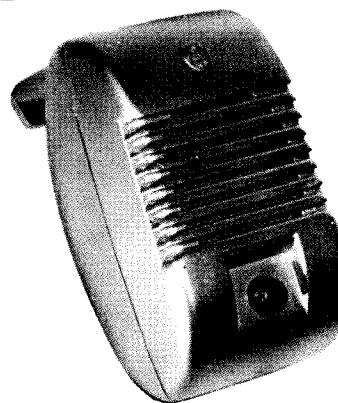

## IN-CAR SPEAKER

**Painted**

- 9154 with straight cord
- ~~9153 with coiled cord~~
- 9181 with theftproof cord
- 9183 less cord

**Unpainted**

- 9154-U with straight cord
- ~~9153-U with coiled cord~~
- 9182 with theftproof cord
- 9184 less cord

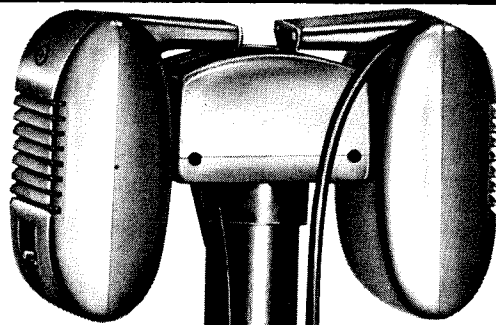

## CBX IN-CAR SPEAKER

*ALL DISCONTINUED*

**Painted**

- 9224 with straight cord
- ~~9225 with coiled cord~~
- 9226 with theftproof cord
- 9227 less cord

**Unpainted**

- 9220 with straight cord
- ~~9221 with coiled cord~~
- 9222 with theftproof cord
- 9223 less cord

# JUNCTION BOXES

## CIRCLITE

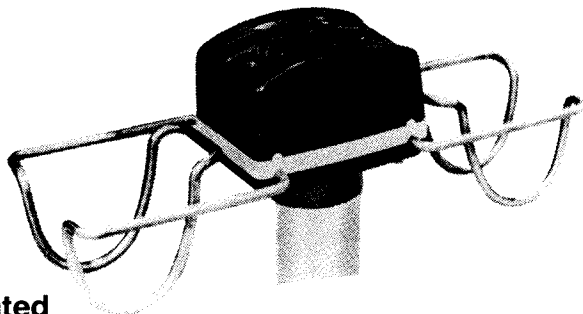

**Painted**

- 9102 Regular (Less Down Light and Diffuser Strip)
- 9101 W/Down Light & Diffuser Strip - Green-Red-White
- 9165 With Down Light Less Diffuser Strip
- 9106 Speaker Basket

**Unpainted**

- 9102-U Regular (Less Down Light and Diffuser Strip)
- 9101-U W/Down Light and Diffuser Strip - Green-Red-White
- 9165-U With Down Light Less Diffuser Strip
- 9106 Speaker Basket

## RCA OLD STYLE

*DISCONTINUED*

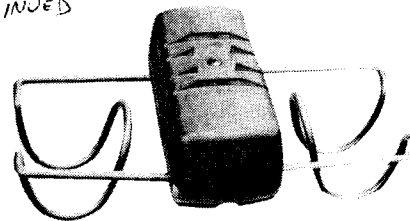

**Painted**

- 9119 All Aluminum (Top and Bottom) Less Down Light
- 9167 All Aluminum (Top and Bottom) with Down Light
- 9118 Alum. Bottom - Plastic Glow Top-Down Light - Red-Green
- 9126 Speaker Basket

**Unpainted**

- 9119-U All Aluminum (Top and Bottom) Less Down Light
- 9167-U All Aluminum (Top and Bottom) With Down Light
- 9118-U Alum. Bottom - Plastic Glow Top - Down Light - Red-Green
- 9126 Speaker Basket

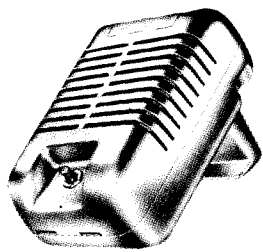

CBX  
**MARK II  
IN-CAR  
SPEAKER**

**REPLACEMENT PARTS**

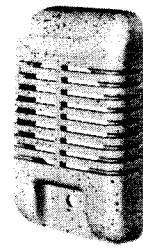

**9302** Mark II Front Speaker Casting (Painted)  
**9305** Unpainted

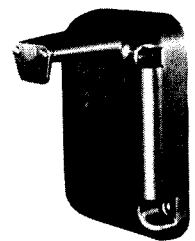

**9303** Mark II Back Speaker Casting, With Hanger Lip (Painted)  
**9306** Unpainted

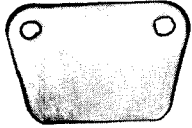

**9304** Mark II Hanger Lip, With Grip Tite Rivets (Painted)  
**9307** Unpainted  
*9308 RIVETS ONLY*

*DISCONTINUED*

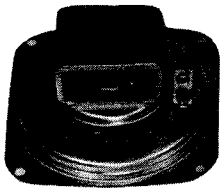

**9137A** Speaker Unit

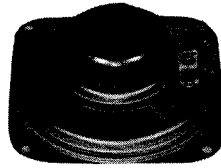

**9137C** Speaker Unit

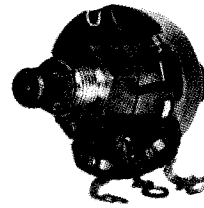

**9163** Volume Control—Knurled Shaft

*X*

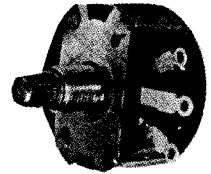

**9168** Wire Wound Volume Control—Knurled Shaft

*DISCONTINUED*

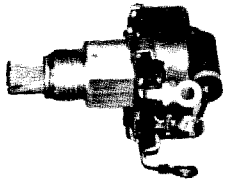

**9250** Volume Control With Automatic Sound Cutoff

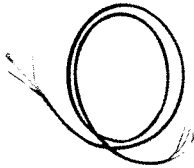

**9172** 6' Theft Proof cord—Neoprene with single steel cable



**9164** 6' SJO Neoprene Straight Cord—Solder Type



**9140** 7' SJO Neoprene Straight Cord—Solder Type

*DISCONTINUED*



**9141** Koil Kord Heavy Duty—SJO Neoprene—Stretch to 10'

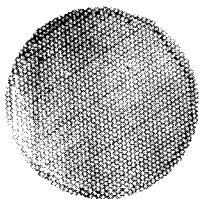

**9138** 4" Grill Guard—Formed Aluminum



**9246** Jumper Wire With Auto Clip Terminals

*8-32 x 1"*



**9247** Housing Screw—Phillips Head

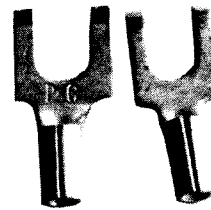

**9179** Spade Lug for #8 Size Screw  
**9324** Spade Lug for #6 Size Screw

*8-32 x 7/8"*

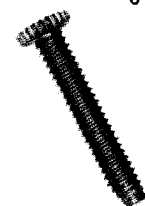

**9248** Housing Screw—Theft Proof—#8 Gulmite Head

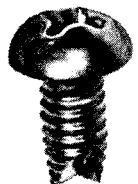

**9149** Speaker Unit Screw

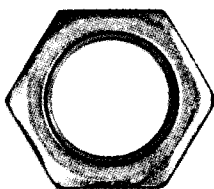

**9147** Volume Control Nut—Aluminum



**9124** Strain Relief Ring



**9166** Theft Proof Screwdriver—#8 Gulmite Screw

**Drive-In  
Theatre  
Mfg. Co.**

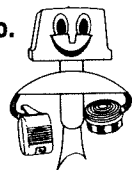

709 North 6th Street  
Kansas City, Kansas 66101

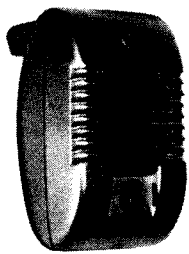

# RCA IN-CAR SPEAKER

## REPLACEMENT PARTS



9134 Front Casting—Painted  
9134U Unpainted



9135 Back Casting—Painted  
9135U Unpainted



9145 Tailpiece with two Rivets — Painted  
9145U — Unpainted

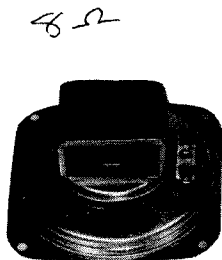

WITH ALNICO MAGNET  
9137A Speaker Unit  
DISCONTINUED

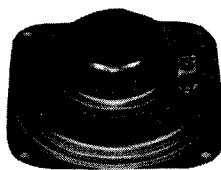

WITH CERAMIC MAGNET  
9137C Speaker Unit

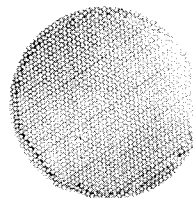

9138 4" Grill Guard

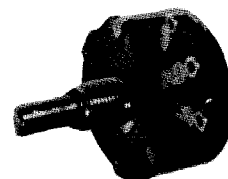

9142 Volume Control



9144 Volume Control Knob

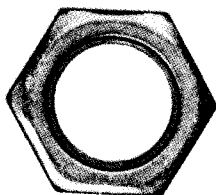

9147 Volume Control Nut—Aluminum

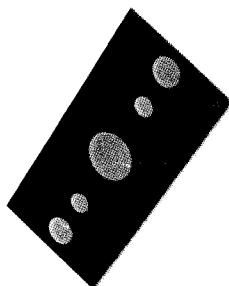

9143 Volume Control Plate—Aluminum



9146 Volume Control Spring



9115 Cable Clamp—Plastic

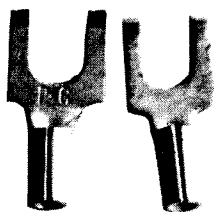

9179 Spade Lug for #8 Size Screw  
9324 Spade Lug for #6 Size Screw

DISCONTINUED



9141 Coiled Kord—Neoprene



9140 7' Straight Cord—Neoprene

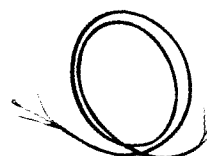

9172 6' Theft Proof cord—Single Cable



9124 Strain Relief Ring

Drive-In  
Theatre  
Mfg. Co.

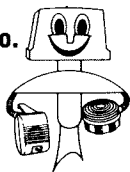

709 North 6th Street  
Kansas City, Kansas 66101

HOLT-3



9173 Theft Proof Screwdriver—3 Flute



9149 Speaker Unit Screw and Volume Control Plate Screw

8-32 x 1"  
HOLT HEAD



9148 Theft Proof Housing Screw—4 Flute

HOLT DRIVER

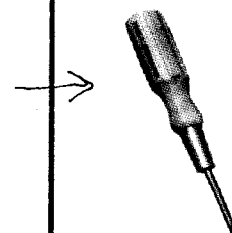

9150 Theft Proof Screwdriver—4 Flute

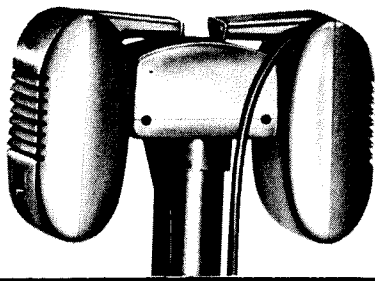

# CBX IN-CAR SPEAKER

## REPLACEMENT PARTS

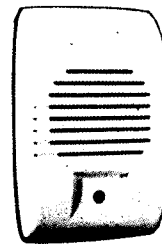

9240 Front Casting—Unpainted  
9241 Painted

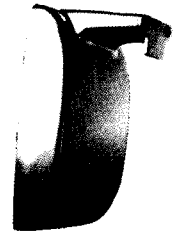

9242 Back Casting with Hanger Lip—Unpainted  
9243 Painted

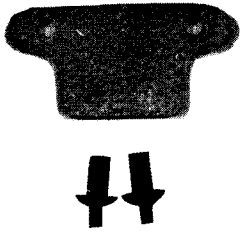

9244 Hanger Lip With 2 Rivets—Unpainted  
9245 Painted

8Ω

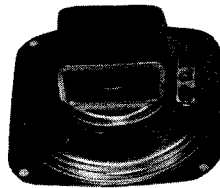

9137A Speaker Unit



9137C Speaker Unit

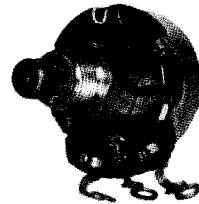

9163 Volume Control—Knurled Shaft

X

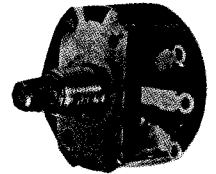

9168 Wire Wound Volume Control—Knurled Shaft

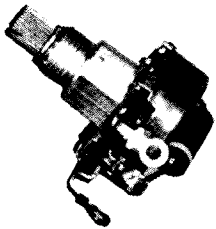

9250 Volume Control With Automatic Sound Cutoff

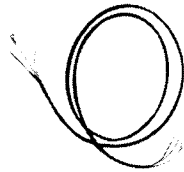

9172 6' Theft Proof cord-Neoprene with single steel cable



9164 6' SJO Neoprene Straight Cord—Solder Type



9140 7' SJO Neoprene Straight Cord—Solder Type

DISCONTINUED



9141 Coil Cord Heavy Duty—SJO Neoprene—Stretch to 10'

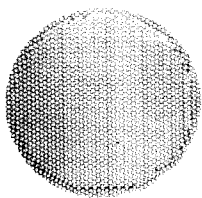

9138 4" Grill Guard—Formed Aluminum



9246 Jumper Wire With Auto Clip Terminals

8-32 x 1"



9247 Housing Screw—Phillips Head



9148 Housing Screw—Theft Proof—4 Slot Holt Head  
USE # 9150 SCREWDRIVER

8-32 x 7/8"



9248 Housing Screw—Theft Proof—#8 Gulmite Head

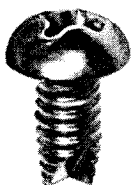

9149 Speaker Unit Screw

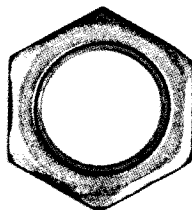

9147 Volume Control Nut—Aluminum

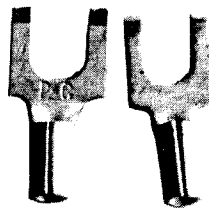

9179 Spade Lug for #8 Size Screw  
9324 Spade Lug for #6 Size Screw



9124 Strain Relief Ring



9166 Theft Proof Screwdriver—#8 Gulmite Screw

# RCA OLD STYLE JUNCTION BOXES

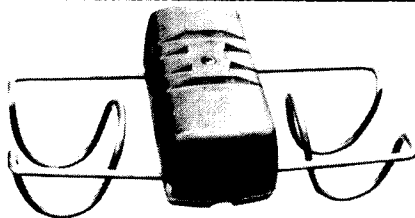

GLO-Top

9122-U Top  
Cover—Metal—Unpainted  
9122 Painted

9120 Top  
Cover—Plastic—Red  
9121 Green

## REPLACEMENT PARTS



9155 Bottom—Metal  
Painted  
9155-U Unpainted

FOR USE WITH  
DOWN LIGHT

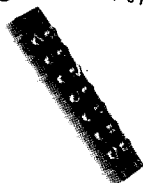

9128 Terminal Strip—7  
Terminals

FOR USE WITHOUT  
DOWN LIGHT



9125 Terminal Strip—5  
Terminals

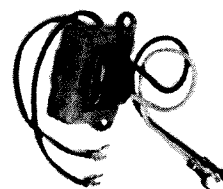

9107 Transformer—Wax  
Dipped

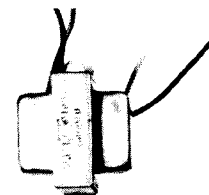

9108  
Transformer—Metal  
Shielded

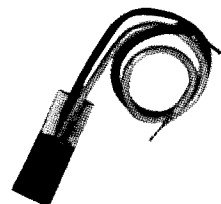

9129 Down Light Socket

1819 or 313



9111 Down Light  
Bulb—28 Volt

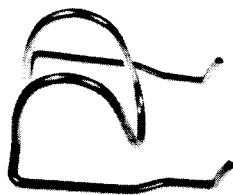

9126 Speaker  
Basket—Aluminum



9127 Speaker  
Basket—Black  
Plasti—Cell-Coated

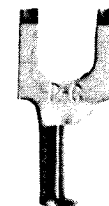

9179 Spade Lug for #8  
Size Screw

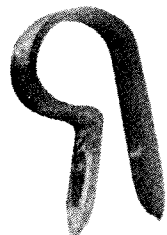

9115 Cable  
Clamp—Plastic



9113 Post Set Screw

1/4" - 20 X 1"



9131 Cover Screw



9116 Terminal Strip  
Screw



9149 Transformer Screw



9180 Speaker Basket  
Screw For Plasti-cell  
Basket

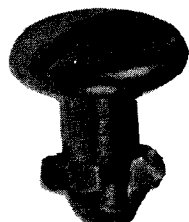

9191 Twist Lock Fastner  
— Male Cover Holder



9192 Cover Fastner —  
Retainer Spring Washer

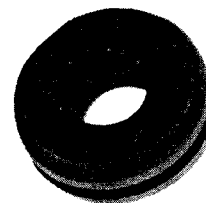

9193 Rubber Gromet for  
Hole in Base

Drive-In  
Theatre  
Mfg. Co.

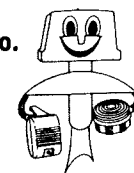

709 North 6th Street  
Kansas City, Kansas 66101



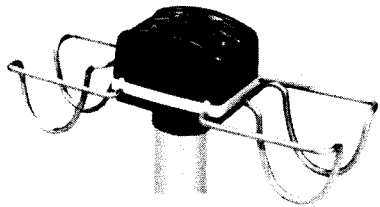

# CIRCLITE JUNCTION BOX

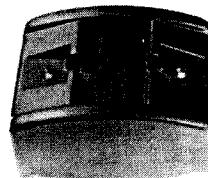

9151 Top Cover—Painted  
9151U Unpainted

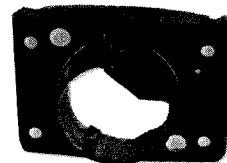

9152 Bottom—Painted  
9152U Unpainted

## REPLACEMENT PARTS

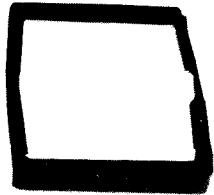

9104 Diffuser Strip—Red  
9103 Diffuser Strip—Green  
9105 Diffuser Strip—White

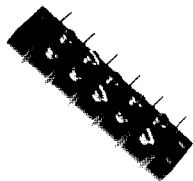

9109 Terminal Strip—5  
Terminals

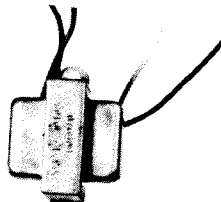

9108 Transformer—Metal  
Shielded

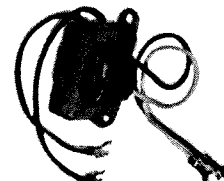

9107 Transformer—Wax  
Dipped

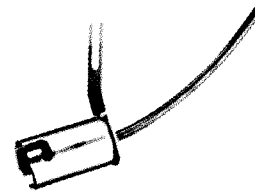

9110 Down Light Socket

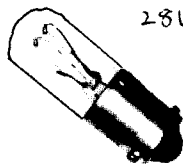

1819  
28VcLT  
9111 Down Light Bulb

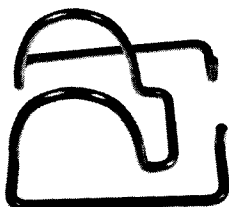

9106 Speaker  
Basket—Aluminum



9115 Cable Clamp—Plastic

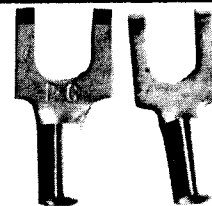

9324 Spade Lug for #6  
Size Screw  
9179 Spade Lug for #8  
Size Screw



9113 Post Set Screw—Allen  
Head



9114 Cover Screw  
(No Diffuser)

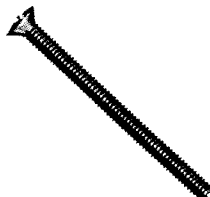

9156 Cover Screw (Use With  
Diffuser)



9116 Terminal Strip Screw



9149 Transformer Screw

Drive-In  
Theatre  
Mfg. Co.

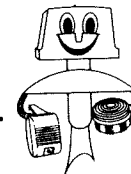

709 North 6th Street  
Kansas City, Kansas 66101

## STANDEE SPEAKER REPLACEMENT PARTS

DISCONTINUED



9260 Front Casting  
Painted

DISCONTINUED



9261 Back Casting  
Painted



9178 6" x 9" Speaker  
Unit

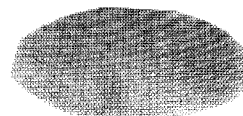

9262 6" x 9" Grill Guard

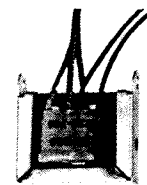

9263 Transformer

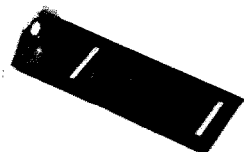

9264 Transformer  
Mounting Bracket

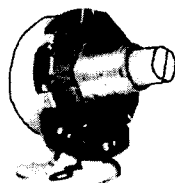

9265 Volume Control,  
Slotted Shaft

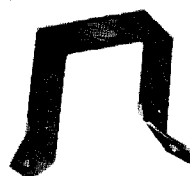

9266 Volume Control  
Mounting Bracket



9267 Post Set Screw



9669 Housing Screw

# SOUND RAMP SWITCHING PANEL

*Isolate ramp with short by the flip of a switch  
prevent sound short out of entire field*

## REVIEW THESE IMPORTANT FEATURES

- 100 Ohm load matching variable transformer
- 100 Ohm Load Matching Variable Transformer
- Monitor Matching Transformer
- Pop-out Indicator Fuses Tells You Which Ramp To Isolate
- Pop-out Fuses Prevent Line Interference
- Front Panel Hinged For Easy Access
- Double Pole Switches Prevent Sound Cross Talk Between Circuits
- Terminal Strip Has Screw Pressure Type for Fast Easy Wiring
- Mounting Strip For Ramp Identification
- 30 Double Pole-Single Throw Switches
- Provides Capacity For the Largest Drive-In

No. 9196

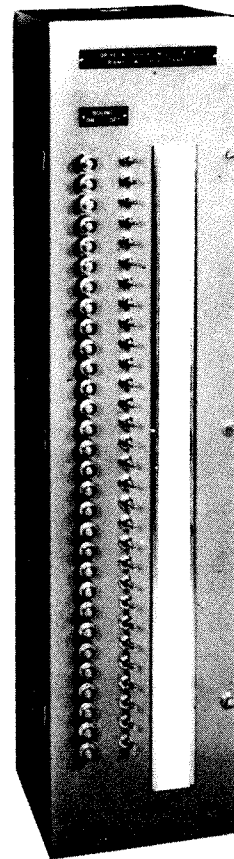

WIRE EACH COMPLETE RAMP WITH PRIVATE HOME RUN TO RAMP CONTROL SWITCHING PANEL

# WIRING DIAGRAMS

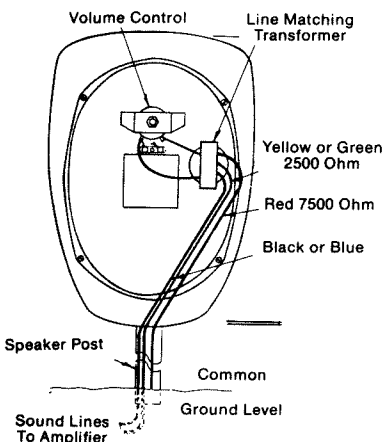

Connect 7500 ohm or 2500 ohm transformer lead to sound line as required by amplifier lines for proper impedance match

### IMPORTANT

Parallel all standee speakers to the feeder lines going to the amplifier. Do not wire in series

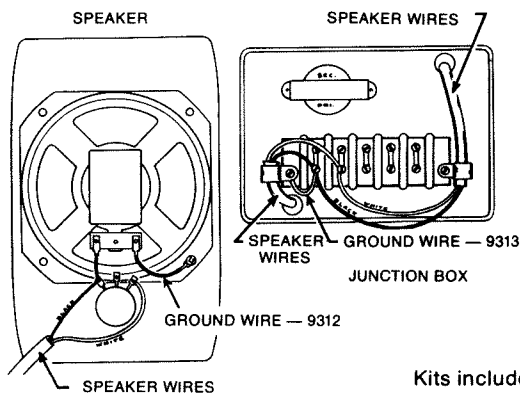

### Sound Cut-off Speaker and Junction Box

Patent No. 3,484,522  
CBX Kit No. 9350  
RCA Kit No. 9252

Other Makes  
Kit No. 9251

Kits include special volume control and ground wires

### Circlite Junction Box Less Downlight

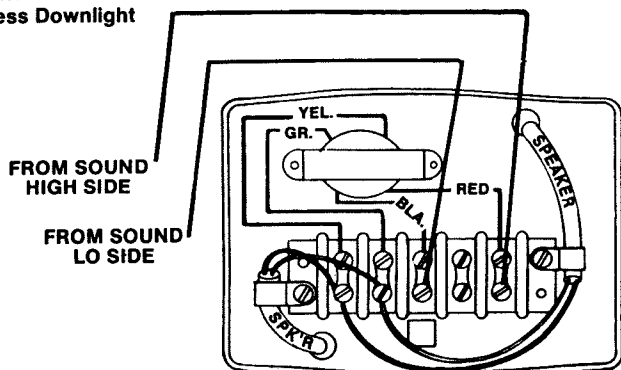

### Circlite Junction Box With Down Light

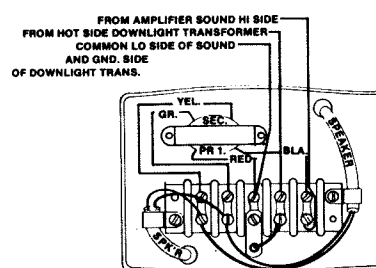

**Note:** Three Wire System For Sound And Downlight Is Suggested For Low Voltage — (28-35 Volts) Only For Downlight.

DRIVE-IN THEATRE MFG. CO., INC.

SOUND CUT-OFF SPEAKER AND JUNCTION BOX

WIRING INSTRUCTIONS

PATENT NO. 3,484,522

CBX Kit No. 9250  
RCA Kit No. 9252  
Other Makes Kit No. 9251

KITS INCLUDE SPECIAL VOLUME CONTROL AND GROUND WIRES

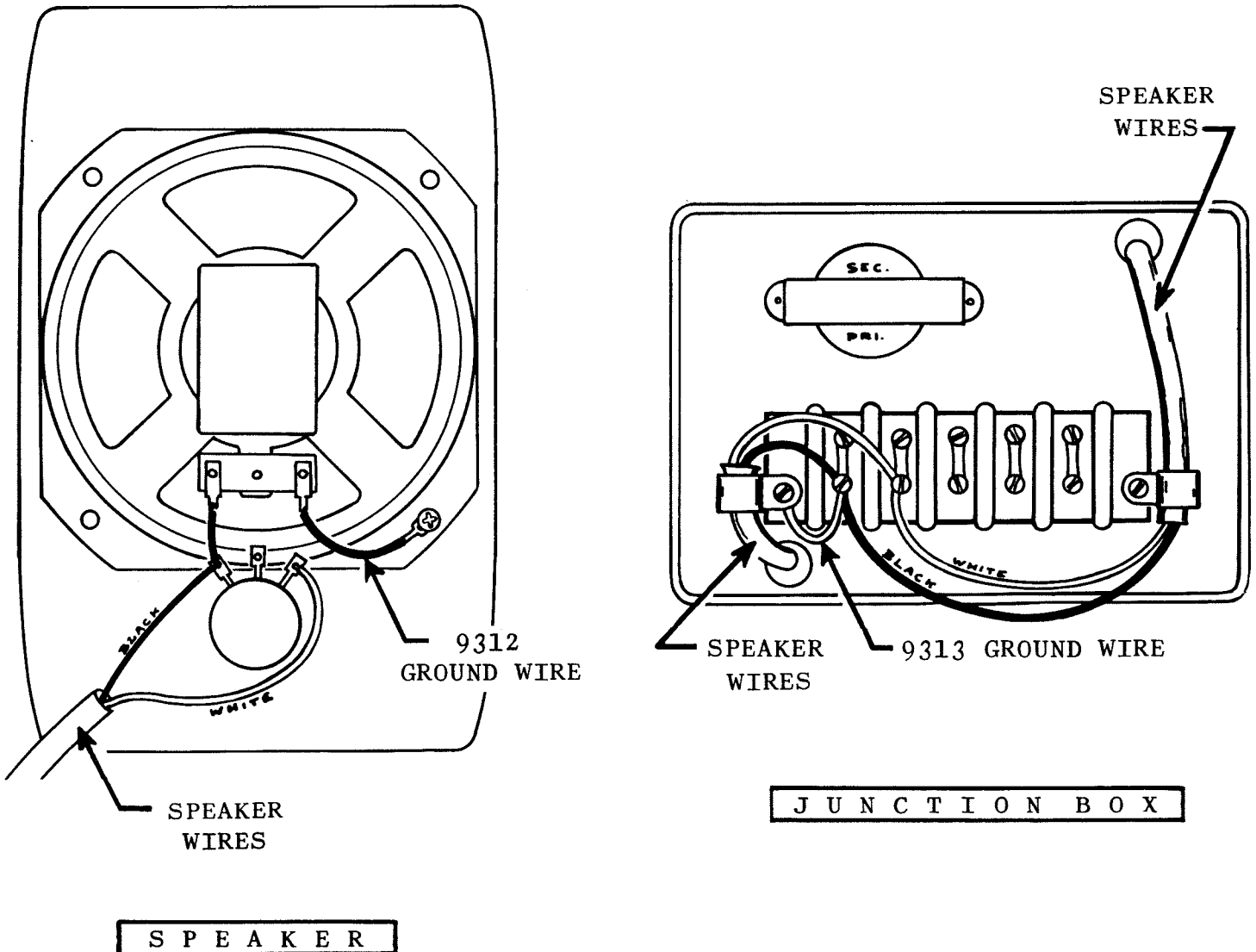

# DRIVE-IN'S SOUND AND DOWN-LITE RAMP CONTROL PANELS

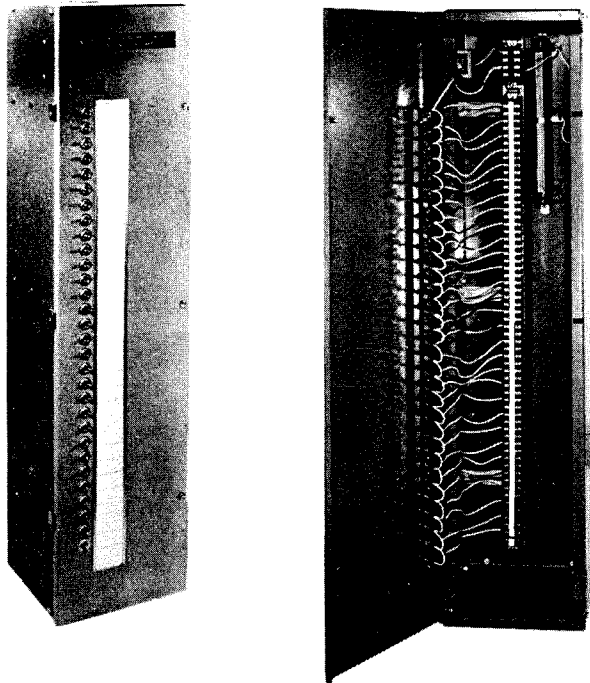

## SOUND RAMP CONTROL PANEL FEATURES

Panel measures 8" x 8" x 36" high and when mounted vertically uses only 8 inches of floor space.

The panel may be mounted horizontally if desired.

Hinged front of panel provides easy access to inside of unit.

30 double-pole single throw switches provide enough circuits for the largest drive-in.

With 30 circuits the SOUND ramp distribution may be divided into left and right circuits to help locate any possible "ramp shorts".

Using double-pole switches both sides of the SOUND lines are disconnected to eliminate and SOUND crosstalk between circuits.

The terminal block strip (60 terminals) are the latest screw pressure type and eliminate the need for the installation man to bend loops in the wires to install under ordinary screw terminals. Simply strip the "Home Run Wires" with straight terminations and insert into the Terminal Block and tighten screw, thus saving much time in original installation as well as tracing all circuits.

On the front of the panel a cardboard mounting strip is provided to show what ramps are controlled by the various switches. Examples: 4 LEFT, 4 RIGHT, ETC.

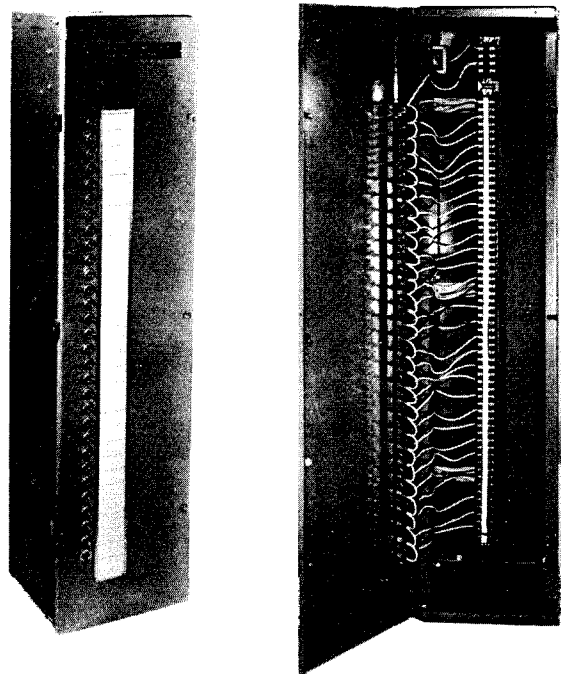

## DOWN-LITE RAMP CONTROL PANEL FEATURES

Panel measures 8" x 8" x 36" high and when mounted vertically uses only 8 inches of floor space.

The panel may be mounted horizontally if desired.

Hinged front of panel provides easy access to inside of unit.

30 double-pole single throw switches provide enough circuits for the largest drive-in.

With 30 circuits the DOWN-LITE ramp distribution may be divided into left and right circuits to help locate any possible "ramp shorts".

Using double-pole switches both sides of the DOWN-LITE lines are disconnected to eliminate any shorts between circuits.

The terminal block strip (60 terminals) are the latest screw pressure type and eliminate the need for the installation man to bend loops in the wires to install under ordinary screw terminals. Simply strip the "Home Run Wires" with straight terminations and insert into the Terminal Block and tighten screw, thus saving much time in original installation as well as tracing all circuits.

On the front of the panel a cardboard mounting strip is provided to show what ramps are controlled by the various switches. Examples: 4 LEFT, 4 RIGHT, ETC.

CONTACT YOUR THEATRE SUPPLY DEALER OR CONTACT "DRIVE-IN"  
**DRIVE-IN Theatre MFG. CO., INC. 709 NORTH SIXTH STREET, KANSAS CITY, KANSAS 66101**  
Call (913) 321-3978

DEVELOPED  
BY  
RCA

RCA  
SPEAKER  
REPLACEMENT PARTS

EXCLUSIVELY  
MANUFACTURED  
BY  
"DRIVE IN"

ONLY "DRIVE IN" MANUFACTURES COMPLETE REPLACEMENT PARTS FOR RCA

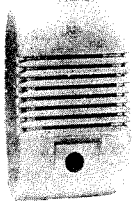

SPEAKER FRONT

	DR. IN NO.	RCA NO.
PAINTED	9134	58950
UNPAINTED	9134-U	96475



SPEAKER BACK

	DR. IN NO.	RCA NO.
PAINTED	9135	58951
UNPAINTED	9135-U	96476



TAIL PIECE

	DR. IN NO.	RCA NO.
<i>PAINTED</i>	<i>9145</i>	
UNPAINTED	9145-U	226242

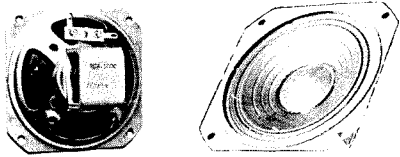

SPEAKER UNIT-4"

	DR. IN NO.	RCA NO.
1.00 OZ.	9136	MI-9419
1.47 OZ.	9137	MI-9420

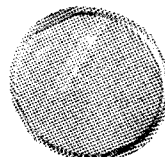

GRILL GUARD

	DR. IN NO.	RCA NO.
4"	9138	226317

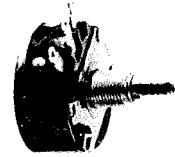

*WIREWOUND  
RHEOSTAT* VOLUME CONTROL

	DR. IN NO.	RCA NO.
<i>50Ω 2WATT</i>	9142	51571



ALUMINUM  
VOLUME CONTROL NUT

	DR. IN NO.	RCA NO.
	9147	51473

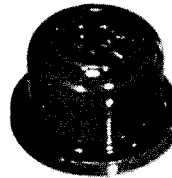

*RED*  
VOLUME CONTROL KNOB

	DR. IN NO.	RCA NO.
PLASTIC	9144	58952



ALUMINUM  
VOLUME CONTROL PLATE

	DR. IN NO.	RCA NO.
	9143	58467



VOLUME CONTROL SPRING

	DR. IN NO.	RCA NO.
	9146	40708

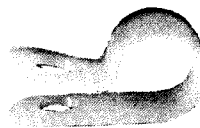

CABLE CLAMP

	DR. IN NO.	RCA NO.
PLASTIC	9115	209861



SPADE TERMINAL

	DR. IN NO.	RCA NO.
NO. 8	9179	57224

DRIVE IN THEATRE MANUFACTURING COMPANY

709 NORTH SIXTH STREET  
KANSAS CITY, KANSAS 66101

FAIRFAX 1-3978-79-80

AREA CODE 913

DEVELOPED

BY  
R C A

R C A  
SPEAKER  
REPLACEMENT PARTS

EXCLUSIVELY  
MANUFACTURED  
BY  
"DRIVE IN"

ONLY "DRIVE IN" MANUFACTURES COMPLETE REPLACEMENT PARTS FOR RCA



*DISCONTINUED*  
KOILED KORD

DR. IN NO. RCA NO.

NEOPRENE	9141	52240
----------	------	-------

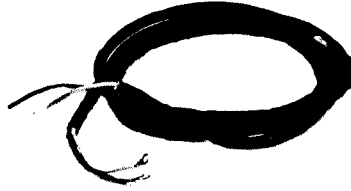

7 FOOT  
STRAIGHT CORD

DR. IN NO. RCA NO.

NEOPRENE	9140	51573
----------	------	-------

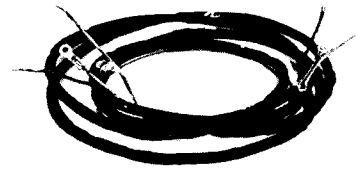

THEFT PROOF CORD

DR. IN NO. RCA NO.

SINGLE CABLE	9172	226321-W
DOUBLE CABLE	9187	226322-T



STRAIN RELIEF RING

DR. IN NO. RCA NO.

FOR SPEAKER CORD	9124	93551
------------------------	------	-------

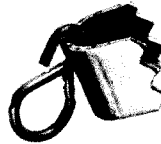

STRAIN RELIEF CLAMP & HOOK

DR. IN NO. RCA NO.

FOR SPEAKER CORD	9123	203031
------------------------	------	--------



*HOLT-3*

THEFT PROOF SCREW DRIVER

DR. IN NO. RCA NO.

3 FLUTE	9173	226320
---------	------	--------



SPEAKER UNIT SCREW  
& VOLUME CONTROL  
PLATE SCREW

DR. IN NO. RCA NO.

<i>8-32 x 5/16"</i>	9149	51552
---------------------	------	-------

*8-32 x 1"*  
*HOLT HEAD*



THEFT PROOF  
HOUSING SCREW

DR. IN NO. RCA NO.

4 FLUTE	9148	57418
---------	------	-------



*HOLT-4*

THEFT PROOF SCREW DRIVER

DR. IN NO. RCA NO.

4 FLUTE	9150	226243
---------	------	--------

DRIVE IN THEATRE MANUFACTURING COMPANY

709 NORTH SIXTH STREET  
KANSAS CITY, KANSAS 66101

FAIRFAX 1-3978-79-80

AREA CODE 913

DEVELOPED

BY  
R C A

R C A

# "IMPAC" SPEAKER

## REPLACEMENT PARTS

EXCLUSIVELY  
MANUFACTURED  
BY  
"DRIVE IN"

ONLY "DRIVE IN" MANUFACTURES COMPLETE REPLACEMENT PARTS FOR RCA

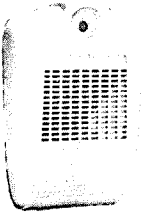

**FRONT**

DR. IN NO. RCA NO.

STYRENE IMPAC	9174	212518
------------------	------	--------

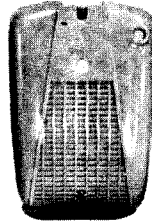

**BACK**

DR. IN NO. RCA NO.

STYRENE IMPAC	9175	212519
------------------	------	--------

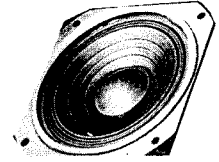
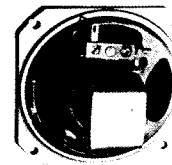

**SPEAKER UNIT**

1.00 OUNCE MAGNET  
DR. IN NO.

RCA NO.

4"	9136	MI-9419
----	------	---------

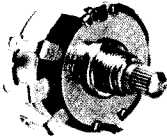

**VOLUME CONTROL**

DR. IN NO. RCA NO.

	9176	212300
--	------	--------



**ALUMINUM  
VOLUME CONTROL NUT**

DR. IN NO. RCA NO.

	9147	51473
--	------	-------

*DISCONTINUED*



**KOILED KORD**

DR. IN NO. RCA NO.

NEOPRENE	9141	52240
----------	------	-------



**STRAIGHT CORD**

DR. IN NO. RCA NO.

NEOPRENE	9140	51573
----------	------	-------

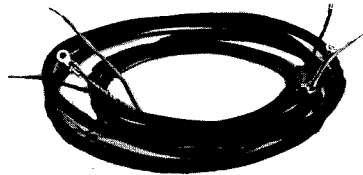

**THEFT PROOF CORD**

DR. IN NO. RCA NO.

SINGLE CABLE	9172	226321-W
DOUBLE CABLE	9187	226322-T



**SPEAKER UNIT SCREW**

DR. IN NO. RCA NO.

	9149	212298
--	------	--------



**HOUSING SCREW**

DR. IN NO. RCA NO.

	9178	212299
--	------	--------

**DRIVE IN THEATRE MANUFACTURING COMPANY**

**709 NORTH SIXTH STREET**

**KANSAS CITY, KANSAS 66101**

**FAIRFAX 1-3978-79-80**

**AREA CODE 913**

**Drive-In's**®

RCA "CircLite"  
**JUNCTION BOX**

"OUTSHINES  
'EM ALL"

## 3 - STYLES

MAKE YOUR DRIVE-IN THE MOST BEAUTIFUL THEATRE IN TOWN

THE "CIRCLITE" OFFERS A CHOICE  
OF  
RED - GREEN - WHITE DIFFUSERS

NO MORE PLASTIC TOPS TO BREAK

DIFFUSER STRIPS BETWEEN TOP & BOTTOM CASTING

GUIDE YOUR PATRONS TO HEATER LOCATIONS

USING GLOWING RED DIFFUSER

USE GREEN OR WHITE FOR NO HEATERS

PROVIDE CONVENIENCE—ADD COLOR—PROTECT SPEAKER POST

**RUGGED DIE CAST ALUMINUM HOUSINGS**

**LONG LIFE — OPERATING SAVINGS**

**BAKED ENAMEL FINISH**

**OR**

**NATURAL ALUMINUM**

**MOUNTS ON 1½" OR 2" PIPE**

**SPEAKER BASKETS FORMED FROM HARD 5/16" ALUMINUM ROD**

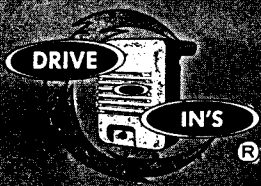

709 NORTH SIXTH STREET KANSAS CITY, KANSAS 66101 FAIRFAX 1-3978-79-80



DEVELOPED

BY  
R C A

R C A  
JUNCTION BOX REPLACEMENT PARTS  
(NEW STYLE)

EXCLUSIVELY  
MANUFACTURED  
BY  
"DRIVE IN"

ONLY "DRIVE IN" MANUFACTURES COMPLETE REPLACEMENT PARTS FOR RCA

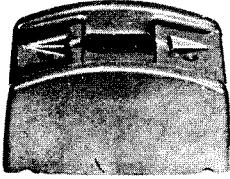

TOP COVER

DR. IN NO. RCA NO.

PAINTED	9151	226248
UNPAINTED	9151-U	226249

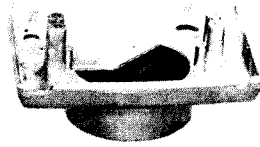

BOTTOM

DR. IN NO. RCA NO.

PAINTED	9152	226250
UNPAINTED	9152-U	226251

DIFFUSER STRIP-PLASTIC

DR. IN NO. RCA NO.

RED	9104	226255
GREEN	9103	226254
WHITE	9105	226256

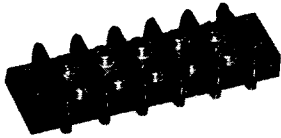

TERMINAL STRIP

DR. IN NO. RCA NO.

5 TERMINALS	9109	207998
-------------	------	--------



TRANSFORMER

DR. IN NO. RCA NO.

WAX DIPPED	9107	57686
------------	------	-------



TRANSFORMER

DR. IN NO. RCA NO.

METAL SHIELDED	9108	226315
----------------	------	--------

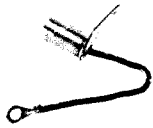

DOWN LIGHT SOCKET *ONLY*

DR. IN NO. RCA NO.

LESS BULB	9110	210792
-----------	------	--------

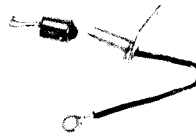

DOWN LIGHT KIT

DR. IN NO. RCA NO.

SOCKET & BULB	9112	226257
---------------	------	--------

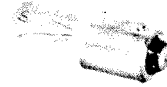

DOWN LIGHT BULB *ONLY*

DR. IN NO. RCA NO.

28 VOLTS	9111	68016
----------	------	-------

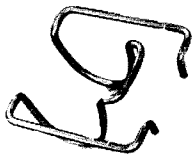

SPEAKER BASKET

DR. IN NO. RCA NO.

UNPAINTED	9106	226252
-----------	------	--------



CABLE CLAMP

DR. IN NO. RCA NO.

PLASTIC	9115	209861
---------	------	--------



SPADE TERMINAL

DR. IN NO. RCA NO.

NO. 8	9179	57224
-------	------	-------

DRIVE IN THEATRE MANUFACTURING COMPANY

709 NORTH SIXTH STREET

KANSAS CITY, KANSAS 66101

FAIRFAX 1-3978-79-80

AREA CODE 913

DEVELOPED

BY

R C A

R C A

JUNCTION BOX REPLACEMENT PARTS

(NEW STYLE)

EXCLUSIVELY  
MANUFACTURED

BY

"DRIVE IN"

ONLY "DRIVE IN" MANUFACTURES COMPLETE REPLACEMENT PARTS FOR RCA



POST SET SCREW

DR. IN NO. RCA NO.

ALLEN HEAD	9113	209859
------------	------	--------



COVER SCREW

DR. IN NO. RCA NO.

USE LESS DIFFUSER	9114	209860
-------------------	------	--------



COVER SCREW

DR. IN NO. RCA NO.

USE WITH DIFFUSER	9156	226308
-------------------	------	--------



TERMINAL STRIP SCREW

DR. IN NO. RCA NO.

	9116	51550
--	------	-------



TRANSFORMER SCREW

DR. IN NO. RCA NO.

	9149	51552
--	------	-------

DRIVE IN THEATRE MANUFACTURING COMPANY

709 NORTH SIXTH STREET

KANSAS CITY, KANSAS 66101

FAIRFAX 1-3978-79-80

AREA CODE 913

**Drive-In's**®

# RCA OLD STYLE JUNCTION BOX

DIE CAST ALUMINUM  
FOR  
LONG LIFE

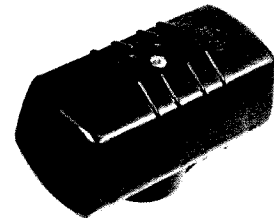
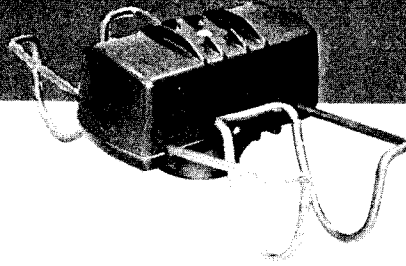

THOROUGHLY TESTED

**AVAILABLE FOR THOSE WHO WISH TO MATCH EXISTING FIELDS**

SPEAKER BASKETS—DOWNLIGHT—GLOW TOPS OPTIONAL

**AVAILABLE PAINTED OR IN NATURAL ALUMINUM FINISH**

MATCH  
YOUR EXISTING  
FIELDS

**GLOW TOP COVER AVAILABLE RED OR GREEN**

DOWNLIGHT AIDS PATRONS ENTER-  
ING OR LEAVING RAMPS

USE RED GLOW TOPS TO DESIGNATE  
HEATER LOCATIONS

USE GREEN GLOW TOPS FOR NO  
HEATERS

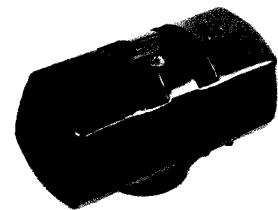

CUSTOM  
TRANSFORMER

A COMPLETE STOCK OF COMPONENT PARTS MAIN-  
TAINED AT ALL TIMES

## **ANOTHER SERVICE BY "DRIVE-IN"**

FOR THOSE WHO REQUIRE THE VERY OLD STYLE  
PLASTI-CELL SPEAKER BASKETS — AMPLE STOCKS  
ARE MAINTAINED FOR PROMPT SHIPMENT

LONG  
LIFE

*Drive-In-Theatre  
Manufacturing Company*

709 NORTH SIXTH STREET KANSAS CITY, KANSAS 66101



DEVELOPED

BY  
R C A

R C A  
(OLD STYLE)

JUNCTION BOX REPLACEMENT PARTS

EXCLUSIVELY  
MANUFACTURED  
BY  
"DRIVE IN"

ONLY "DRIVE IN" MANUFACTURES COMPLETE REPLACEMENT PARTS FOR RCA

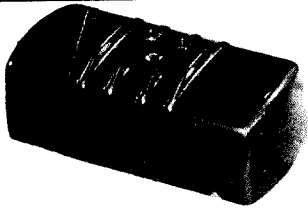

TOP COVER-METAL

DR. IN NO. RCA NO.

UNPAINTED	9122	MI-9585-K
PAINTED	9122-U	MI-9585-T

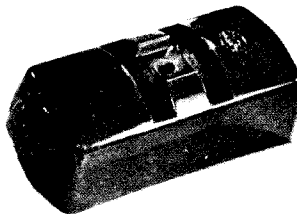

TOP COVER-PLASTIC

DR. IN NO. RCA NO.

RED	9120	226244-R
GREEN	9121	226316-G

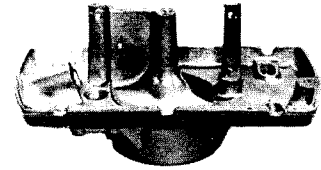

BOTTOM-METAL

DR. IN NO. RCA NO.

PAINTED	9155	MI-9586-K
UNPAINTED	9155-U	MI-9586-T



TERMINAL STRIP

DR. IN NO. RCA NO.

7 TERMINALS	9128	57637
-------------	------	-------



TERMINAL STRIP

DR. IN NO. RCA NO.

5 TERMINALS	9125	53408
-------------	------	-------



TRANSFORMER

DR. IN NO. RCA NO.

WAX DIPPED	9107	57686
------------	------	-------



TRANSFORMER

DR. IN NO. RCA NO.

METAL SHIELDED	9108	226315
----------------	------	--------

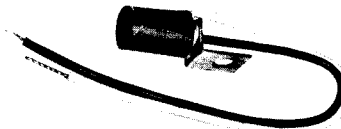

DOWN LIGHT SOCKET

DR. IN NO. RCA NO.

LESS BULB	9129	96778
-----------	------	-------



DOWN LIGHT KIT

DR. IN NO. RCA NO.

SOCKET & BULB	9130	MI-9491-A
---------------	------	-----------

GE. # 313 LAMP

28 VOLT  
170 MA.



DOWN LIGHT BULB

RCA NO. DR. IN NO.

28 VOLT	9111	68016
---------	------	-------



ALUMINUM

SPEAKER BASKET

DR. IN NO. RCA NO.

UNPAINTED	9126	226253
-----------	------	--------

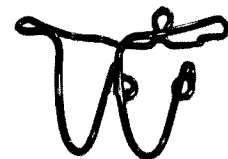

SPEAKER BASKET

DR. IN NO. RCA NO.

BLACK PLASTI-CELL	9127	51717
----------------------	------	-------

DRIVE IN THEATRE MANUFACTURING COMPANY

709 NORTH SIXTH STREET  
KANSAS CITY, KANSAS 66101

FAIRFAX 1-3978-79-80

AREA CODE 913

DEVELOPED

BY  
R C A

R C A  
(OLD STYLE)

JUNCTION BOX REPLACEMENT PARTS

EXCLUSIVELY  
MANUFACTURED  
BY  
"DRIVE IN"

ONLY "DRIVE IN" MANUFACTURES COMPLETE REPLACEMENT PARTS FOR RCA

SPADE TERMINAL

DR. IN NO. RCA NO.

NUMBER 8 9179 57224



CABLE CLAMP

DR. IN NO. RCA NO.

PLASTIC 9115 209861



*3/16 - 16 x 1/2" Long*

POST SET SCREW

DR. IN NO. RCA NO.

9113 209859



COVER SCREW

DR. IN NO. RCA NO.

9131 57639



TERMINAL STRIP  
SCREW

DR. IN NO. RCA NO.

9116 51550



TRANSFORMER SCREW

DR. IN NO. RCA NO.

9149 51552



SPEAKER BASKET SCREW  
FOR PLASTI-CELL BASKET

DR. IN NO. RCA NO.

9180 93825



TWIST LOCK FASTENER-MALE-  
COVER HOLDER

DR. IN NO. RCA NO.

MALE SECTION ONLY 9191 203015



WASHER: COVER FASTENER

DR. IN NO. RCA NO.

RETAINER SPRING WASHER 9192 203016



RUBBER GROMMET  
FOR HOLE IN BASE

DR. IN NO. RCA NO.

FOR 1/32 ONLY 9193 56560

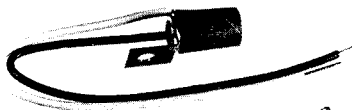

*USE 9129*

DOWNLIGHT SOCKET

DR. IN NO. RCA NO.

EARLY OLD STYLE 9199 57989

DRIVE IN THEATRE MANUFACTURING COMPANY

709 NORTH SIXTH STREET

KANSAS CITY, KANSAS 66101

FAIRFAX 1-3978-79-80

AREA CODE 913

# RCA JUNCTION BOX WITH LIGHT

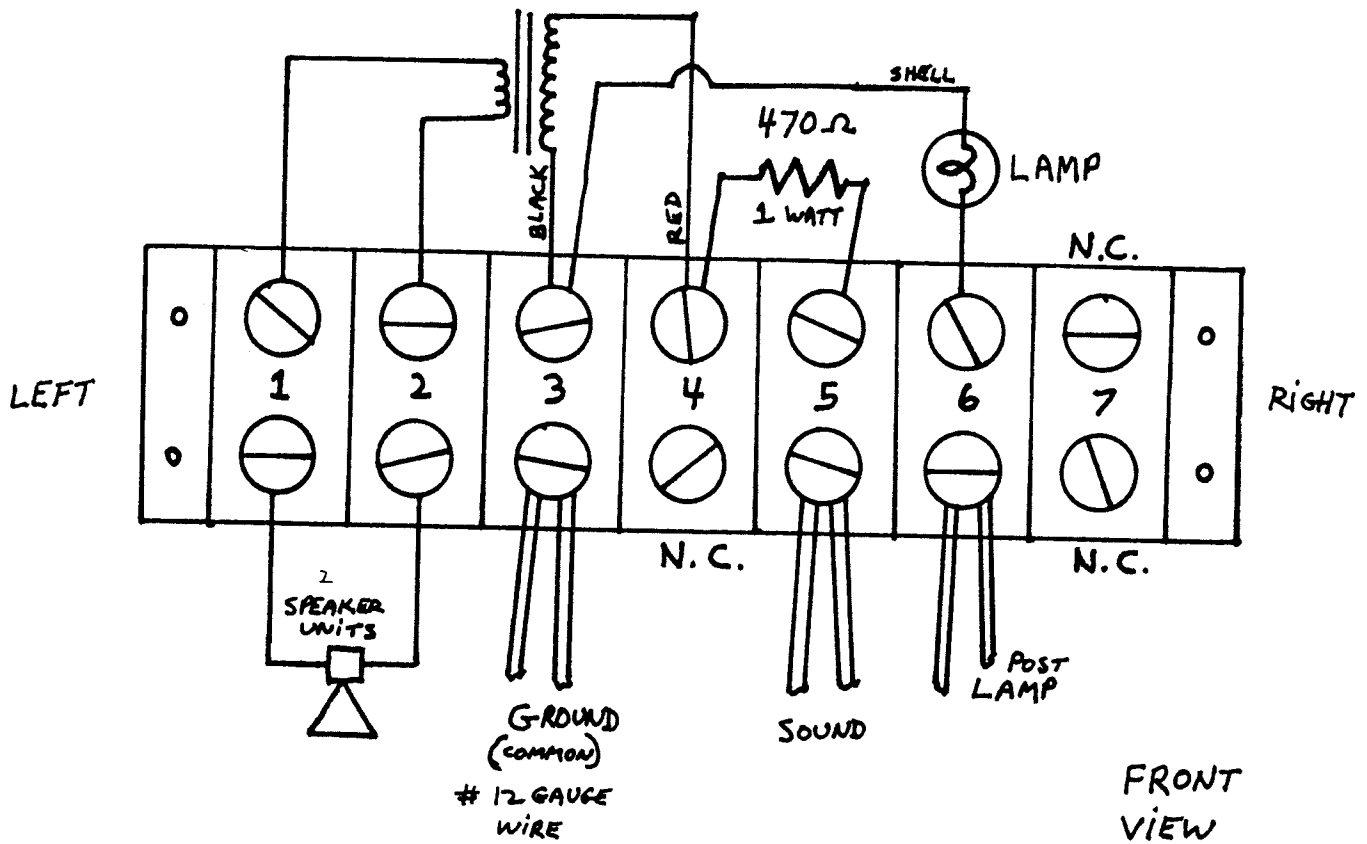

## SCHEMATIC

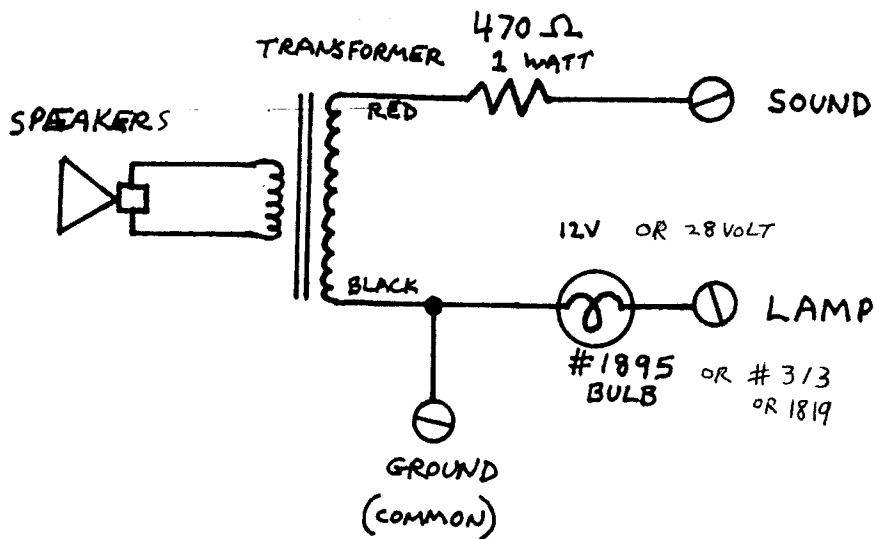

# SIMPLEX

ONLY "DRIVE-IN" MANUFACTURES COMPLETE REPLACEMENT PARTS FOR SIMPLEX  
 JUNCTION BOX REPLACEMENT PARTS

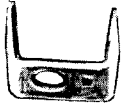

TAPER TAB TERMINAL FOR  
 TERMINAL STRIP

DR. IN NO.	SIMPLEX NO.
9363	P3903

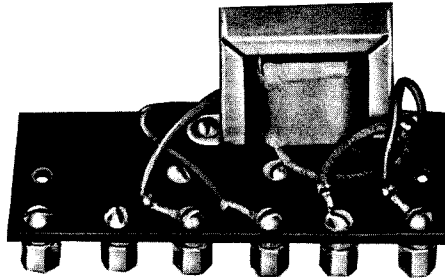

TERMINAL STRIP  
 LESS DOWN LIGHT

DR. IN NO.	SIMPLEX NO.
9367	G2030

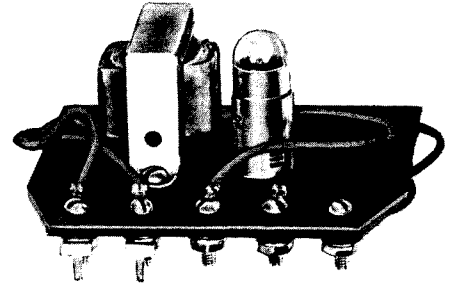

TERMINAL STRIP  
 WITH DOWN LIGHT  
 AND TAPER TABS TERMINALS

DR. IN NO.	SIMPLEX NO.
9370	G2542

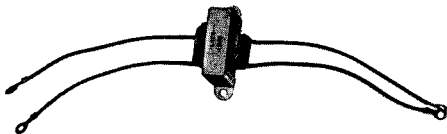

TRANSFORMER

DR. IN NO.	SIMPLEX NO.
9365	P2816



TERMINAL STRIP

DR. IN NO.	SIMPLEX NO.
9368	P2517

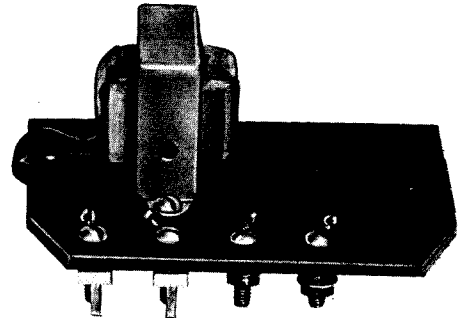

TERMINAL STRIP  
 LESS DOWN LIGHT  
 WITH TAPER TAB TERMINALS

DR. IN NO.	SIMPLEX NO.
9371	G4354

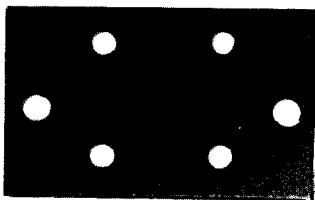

TERMINAL STRIP

DR. IN NO.	SIMPLEX NO.
9366	P1338

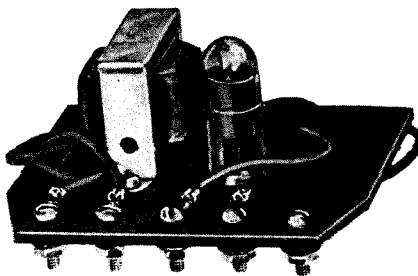

TERMINAL STRIP  
 WITH DOWN LIGHT  
 SCREW TERMINAL

DR. IN NO.	SIMPLEX NO.
9369	G2132

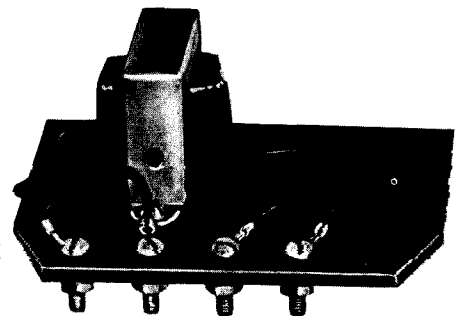

TERMINAL STRIP  
 LESS DOWN LIGHT  
 SCREW TERMINAL

DR. IN NO.	SIMPLEX NO.
9372	G4356

**DRIVE-IN** *theatre*  
 MFG. CO., INC.

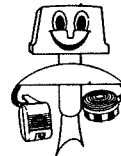

709 NORTH SIXTH STREET KANSAS CITY, KANSAS 66101 FAIRFAX 1-3978-79-80 AREA CODE 913

## JUNCTION BOX REPLACEMENT PARTS

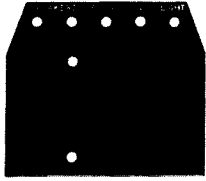

**TERMINAL STRIP,  
LESS SOCKET HOLE**

DR. IN NO.      SIMPLEX NO.

**9373      P4357**

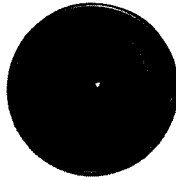

**PLASTIC DOME**

DR. IN NO.      SIMPLEX NO.

**AMBER      9379      P2818**

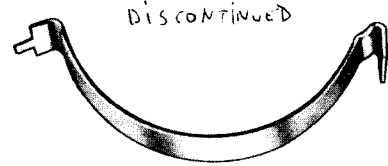

*DISCONTINUED*

**METAL DOME GUARD  
FOR PLASTIC DOMES**

DR. IN NO.

**9384**

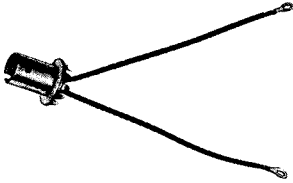

**DOWN LIGHT  
SOCKET AND LEAD**

DR. IN NO.      SIMPLEX NO.

**9374      P2844**



**PLASTIC DOME**

DR. IN NO.      SIMPLEX NO.

**BLUE      9380      P3545**



**WASHER**

DR. IN NO.      SIMPLEX NO.

**BRASS      9687      P1145**

*28VOLT 170MA DC. BAYONET  
BASE*

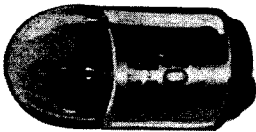

**GE302 DOWN LIGHT LAMP BULB**

DR. IN NO.      SIMPLEX NO.

**9376      P2560**

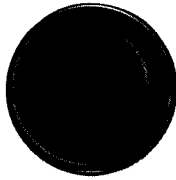

**PLASTIC DOME**

DR. IN NO.      SIMPLEX NO.

**RED      9381      P3835**



**NUT-TERMINAL**

DR. IN NO.      SIMPLEX NO.

**9690      P2567**



**SPRING CLIP-HOLDS  
TOP OF JUNCTION  
BOX-PKG. OF 50**

DR. IN NO.      SIMPLEX NO.

**9377      P2815**

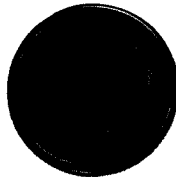

**PLASTIC DOME**

DR. IN NO.      SIMPLEX NO.

**GREEN      9382      P3836**



**NUT FOR DOME SCREW**

DR. IN NO.      SIMPLEX NO.

**9693      PA2522**

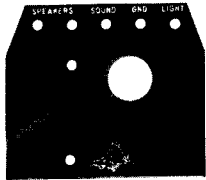

**TERMINAL BOARD  
WITH SOCKET HOLE**

DR. IN NO.      SIMPLEX NO.

**9378      P2817**

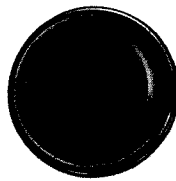

**PLASTIC DOME**

DR. IN NO.      SIMPLEX NO.

**NAT. COLOR      9383      P4363**



**SCREW-TERMINAL BOARD**

DR. IN NO.      SIMPLEX NO.

**9694      H2704**



## JUNCTION BOX REPLACEMENT PARTS

## SPEAKER REPLACEMENT PARTS

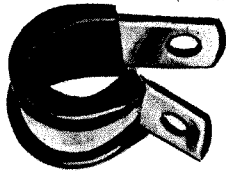

**CABLE CLAMP**

DR. IN NO.	SIMPLEX NO.
9695	P2587



**NUT-TERMINAL**

DR. IN NO.	SIMPLEX NO.
BRASS 9713	H3248

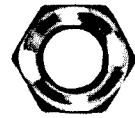

**VOLUME CONTROL NUT**

DR. IN NO.	SIMPLEX NO.
ALUMINUM 9147	H3243

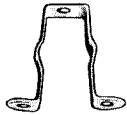

**DOME SUPPORT BRACKET**

DR. IN NO.	SIMPLEX NO.
9696	P2516



**WASHER-TERMINAL**

DR. IN NO.	SIMPLEX NO.
BRASS 9714	H3324



**JUMPER WIRE-TAPER TAB  
TERMINALS BOTH ENDS**

DR. IN NO.	SIMPLEX NO.
9171	G2571



**SET SCREW-COUPLING UNIT**

DR. IN NO.	SIMPLEX NO.
9697	H3715



**SCREW-TERMINAL**

DR. IN NO.	SIMPLEX NO.
BRASS 9715	H1050



**SPADE TERMINAL NO. 8**

DR. IN NO.	SIMPLEX NO.
9179	P3084



**SET SCREW-COUPLING UNIT**

DR. IN NO.	SIMPLEX NO.
9698	H3716

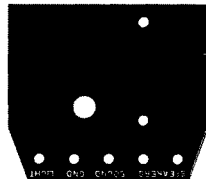

**TERMINAL BOARD-FOR USE WITH  
OR WITHOUT DOWNLIGHT**

DR. IN NO.
9732



**TAPER TAB TERMINAL FOR  
P3903 TAPER TAB**

DR. IN NO.	SIMPLEX NO.
9322	P3952

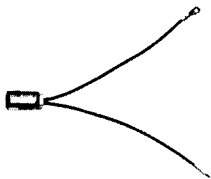

**SOCKET DOWNLIGHT-  
SCREWTYPE BASE**

DR. IN NO.
9704



**RING TERMINAL**

DR. IN NO.
9733

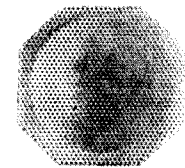

**GRILL GUARD - 3-1/2"**

DR. IN NO.	SIMPLEX NO.
9342	P2893

## SPEAKER REPLACEMENT PARTS

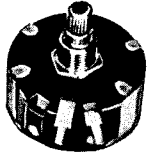

**VOLUME CONTROL-  
KNURLED SHAFT-  
TAPER TAB TERMINALS**

DR. IN NO.	SIMPLEX NO.
9358	P4333

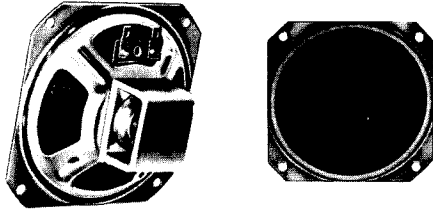

**4" SPEAKER UNIT FOR  
SIMPLEX SPEAKERS**

<i>DISCONTINUED</i>	DR. IN NO.	SIMPLEX NO.
	9663	P3900



**SCREW-CASE SHORT**

DR. IN NO.	SIMPLEX NO.
9731	H2735

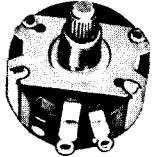

**VOLUME CONTROL-  
KNURLED SHAFT-  
SOLDER TYPE TERMINALS**

DR. IN NO.	SIMPLEX NO.
9359	P3078

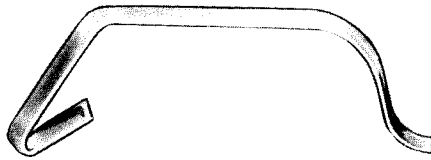

**SPRING CLIP**

DR. IN NO.	SIMPLEX NO.
9688	P3017



*DISCONTINUED*  
**STRAIGHT CORD W/TAPER TAB  
TERMINALS BOTH ENDS**

DR. IN NO.	SIMPLEX NO.
9734	G2540

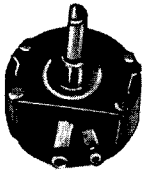

**VOLUME CONTROL-  
SPLIT SHAFT-  
SOLDER TYPE TERMINALS**

DR. IN NO.	SIMPLEX NO.
9360	P3018



**SPRING CLIP**

DR. IN NO.	SIMPLEX NO.
9689	P2846



*DISCONTINUED*  
**STRAIGHT CORD W/TAPER TAB  
TERMINALS**

DR. IN NO.	SIMPLEX NO.
9735	G4351

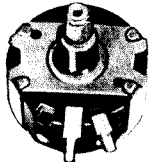

**VOLUME CONTROL-  
SPLIT SHAFT-  
TAPER TAB TERMINALS**

DR. IN NO.	SIMPLEX NO.
9361	P3901 V



**SCREW-CASE LONG**

DR. IN NO.	SIMPLEX NO.
9692	H2740

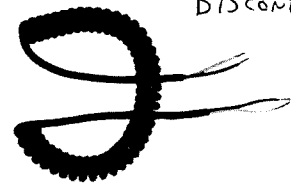

*DISCONTINUED*  
**KOIL KORD W/TAPER TAB  
TERMINALS BOTH ENDS**

DR. IN NO.	SIMPLEX NO.
9736	G2541



**COIL SPRING-FOR USE IN  
HOLDING DOWN SPEAKER UNIT  
IN DELUXE MODELS**

DR. IN NO.	SIMPLEX NO.
9364	P3020



709 North 6th Street • Kansas City, Kansas 66101  
Area Code 913—FA 1-3978

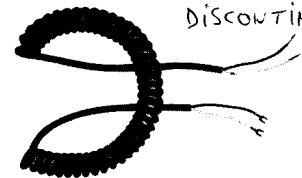

*DISCONTINUED*  
**KOIL KORD W/TAPER TAB  
TERMINALS ONE END-OTHER END  
SPADE LUGS**

DR. IN NO.	SIMPLEX NO.
9737	G4352